



PG Parts™ Catalog

Thermo King Quality replacement parts for your Carrier® units



EXPERT SERVICE AND SUPPORT ARE AS CLOSE AS THIS SIGN.



Enjoy the support of the

**Thermo King
Dealer Network.**



Over 200 factory-authorized service centers nationwide-

FIND ONE NEARBY AT WWW.THERMOKING.COM

Thank you for taking a look at Thermo King PG Parts™. We are proud to offer you a wide assortment of Thermo King-quality parts for your Carrier® units. You can be assured that the Thermo King tradition of engineering excellence has been built into each and every PG Part.

All PG Parts are engineered to meet or exceed OEM specifications and have a nationwide warranty backed by over 200 dealers and service centers. We are happy to provide our customers a high quality, competitive and convenient alternative to Carrier aftermarket parts.

Table of Contents:

ENGINES.....	2-30
Engine Cross Reference	2
Remanufactured Engines	4
Engine Overhaul Kits	7
Filters	11
Hoses	16
Injectors	21
Water Pumps	25
Starters	26
COMPRESSOR.....	31-41
Remanufactured Compressors	31
REFRIGERATION	43-51
Coils	43
Driers	43
Solenoids	45
Valves	47
Vibrasorbors	50
ELECTRICAL	53-68
Alternators	53
Switches	64
DRIVE.....	69-77
Belts	70
Clutches	73
Pulleys	76
Fan Shafts	77
STRUCTURAL.....	79-94
Replacement Doors	83
BUS	85-89
CONTAINER	91-108
COMFORT PRO	109-111
WARRANTY	113
UNIT REFERENCE CHART	114-115
ALPHA INDEX WITH APPLICATION DATA	116
NUMERIC INDEX WITH APPLICATION DATA	145

Truck & Trailer Parts – ENGINE

ENGINE

Unit Name	Unit Model	Refrigerant	Carrier Engine #	OEM Engine #	Comp	Option	Volt
Eagle	NDB-402	12	Perkins	4/108	05G41		
	NDB-406	12	Mitsubishi	4DQ50	05G41		
Eagle Plus	NDB-401	12	CT4-134DI	V2203DI	05G41		
	NDB-405	12	CT4-114IDI	V1902IDI	05G41		
	NDB-408	12	CT4-114DI	V1902DI	05G41		
	NDB-409	12	CT4-134TV	V2203TV	05G41		
	NDB-461	500	CT4-134DI	V2203DI	05G41		
	NDB-465	500	CT4-114IDI	V1902IDI	05G41		
	NDB-468	500	CT4-114DI	V1902DI	05G41		
	NDB-469	500	CT4-134TV	V2203TV	05G41		
	NDB-491	502	CT4-134DI	V2203DI	05G41		
	NDB-495	502	CT4-114IDI	V1902IDI	05G41		
	NDB-498	502	CT4-114DI	V1902DI	05G41		
	NDB-499	502	CT4-134TV	V2203TV	05G41		
	NDS-405N2	12	CT4-114IDI	V1902IDI	05G41	Standby	230
	NDS-405N6	12	CT4-114IDI	V1902IDI	05G41	Standby	460
	NDS-408N2	12	CT4-114DI	V1902DI	05G41	Standby	230
NDS-408N6	12	CT4-114DI	V1902DI	05G41	Standby	460	
Euro-Phoenix	NDA	12	CT4-114IDI	V1902IDI	05G41	Standby	230/380
Euro-Phoenix Plus	NDM	12	CT4-114IDI	V1902IDI	05G41	Standby	230/380
Extra	NDA-93E	404A	CT4-114TV	V1903TV	05G37	Standby	230
	NDA-94E	22	CT4-114TV	V1903TV	05G37		
	NDA-94E	22	CT4-114TV	V1903TV	05G37	Standby	230
	NDM-93E	404A	CT4-114TV	V1903TV	05G37	Standby	230
	NDM-93E Euro	404A	CT4-114TV	V1903TV	05G37	Standby	380
Genesis TM1000	NDM-94E	22	CT4-114TV	V1903TV	05G37	Standby	230
	NDM-94E Euro	22	CT4-114TV	V1903TV	05G37	Standby	380
Genesis TM900	NDA93__W	404A	CT4-134DI/TV	V2203DI/V2203TV	05G41	Multi-Temp	
	NDA94__W	22	CT4-134DI/TV	V2203DI/V2203TV	05G41	Multi-Temp	
	NDA93__N	404A	CT4-134DI/TV	V2203DI/V2203TV	05G37	Multi-Temp	
Maxima	NDA94__N	22	CT4-134DI/TV	V2203DI/V2203TV	05G37	Multi-Temp	
	8000201	22	CT4-91TV	V1505	05K24	Standby	380
	8000268	22	CT4-91TV	V1505	05K24		
	8000282	22	CT4-91TV	V1505	05K24	Standby	380
	8000285	22	CT4-91TV	V1505	05K24	Standby	380
	8000286	22	CT4-91TV	V1505	05K24		
	8000307	22	CT4-91TV	V1505	05K24		
	8000308	22	CT4-91TV	V1505	05K24	Standby	380
8000309	22	CT4-91TV	V1505	05K24			
Maxima 2 (Continued Next Page)	8001193	22	CT4-91TV	V1505	05K24	Standby	380
	8001194	404A	CT4-91TV	V1505	05K24	Standby	380
	8001216	22	CT4-91TV	V1505	05K24	Standby	380
	8001217	404A	CT4-91TV	V1505	05K24	Standby	380
	8001218	22	CT4-91TV	V1505	05K24	Standby	380
	8001219	22	CT4-91TV	V1505	05K24		
	8001220	22	CT4-91TV	V1505	05K24		

Truck & Trailer Parts – ENGINE

ENGINE

Unit Name	Unit Model	Refrigerant	Carrier Engine #	OEM Engine #	Comp	Option	Volt
(Maxima 2 Continued)	8001221	404A	CT4-91TV	V1505	05K24	Standby	380
	8001222	404A	CT4-91TV	V1505	05K24	Stop/start	
	8001223	404A	CT4-91TV	V1505	05K24		
	8001224	22	CT4-91TV	V1505	05K24		
	8001225	404A	CT4-91TV	V1505	05K24		
Optima	NDA-93B	404A	CT4-91TV	V1505	05K24		
	NDA-94B	22	CT4-91TV	V1505	05K24		
Phoenix Advantage	NDA-74	22	CT4-134DI/TV	V1902IDI/V2203TV	05G41		
	NDA-76	12/500/502	CT4-114/134DI	V1902IDI/V2203DI	05G41		
	NDA-79	502	CT4-114/134DI	V1902IDI/V2203DI	05G41		
Phoenix Ultra	NDA-93A	404A	CT4-134TV	V2203TV	05G41	Standby	380
	NDA-93A Euro	404A	CT4-134TV	V2203TV	05G37		
	NDA-94	22	CT4-134DI	V2203TV	05G41	Standby	380
	NDA-94A	22	CT4-134TV	V2203TV	05G41		
	NDA-94A Euro	22	CT4-134TV	V2203TV	05G37	Multi-Temp	380
	NDA-94A-M2/3	22	CT4-134TV	V2203TV	05G41		
	NDM-94A	22	CT4-134TV	V2203TV	05G37	Standby	230
	NDM-94A Euro	22	CT4-134TV	V2203TV	05G37	Standby	380
Phoenix Ultra XL	NDA-93D	404A	CT4-134DI	V2203DI	05G41	Standby	380
	NDA-93D Euro	404A	CT4-134DI	V2203DI	05G37		
	NDA-94D	22	CT4-134DI	V2203DI	05G41	Standby	230
	NDM-94D	22	CT4-134DI	V2203DI	05G37		
	NDM-94D Euro	22	CT4-134DI	V2203DI	05G37	Standby	380
Phoenix Xtra	NDA-84	22	CT4-114/134DI	V1902IDI/V2203DI	05G41		
	NDA-85	502	CT4-134TV	V2203TV	05G41		
	NDA-89	502	CT4-114/134DI	V1902IDI/V2203DI	05G41		
Supra 422	TBS-10	22	CT2-29TV	Z482	EF210	Standby	
	TDS-10	22	CT2-29TV	Z482	EF210		
Supra 622	TDB-17	22	CT3-44TV	D722	05K12	Standby	
	TDS-17	22	CT3-44TV	D722	05K12		
Supra 722	TDB-19	22	CT3-44TV	D722	05K12	Standby	
	TDS-19	22	CT3-44TV	D722	05K12		
Supra 922	TDB 36	22	CT3-69TV	D1105	05G37	Standby	460
	TDS 36	22	CT3-69TV	D1105	05G37		
Supra 944	TDB 32	404A	CT3-69TV	D1105	05G37	Standby	460
	TDS 32	404A	CT3-69TV	D1105	05G37		
Thunderbird	NDF-425N2	12	CT4-114/134DI	V1902IDI/V2203DI	05G41	Standby	230
	NDF-425N6	12	CT4-114/134DI	V1902IDI/V2203DI	05G41	Standby	460
	NDJ-42	12	CT4-114/134DI	V1902IDI/V2203DI	05G41		
	NDJ-44	22	CT4-114/134DI	V1902IDI/V2203DI	05G41		
	NDJ-46	500	CT4-114/134DI	V1902IDI/V2203DI	05G41		
	NDJ-49	502	CT4-114/134DI	V1902IDI/V2203DI	05G41		
Ultima	NDX-93D	404A	CT4-134DI	V2203DI	05G41		
Vector	8001334	404A	CT4-134TV	V2203TV	06D		

REMANUFACTURED PG PARTS™ ENGINES FOR YOUR CARRIER® UNITS

CARB-COMPLIANT REMAN ENGINES



134TV

- ✓ A cost-competitive alternative for your CARB compliance needs
- ✓ Remanufactured with CARB-approved “match set” parts, resulting in a Tier II-compliant engine
- ✓ Approved for use in California through 2014



134DI

Part #s	Models	Engine Type
P-26-00119-00CRM	Extra XT, Ultra XT, Ultra XTC, Genesis TM900/TM1000, Smart Air	134DI
P-26-00119-02CRM	Ultima, Ultima 53, Ultima XTC	134DI
P-26-00123-00CRM	Extra	114TV
P-26-00124-00CRM	Ultra, Ultra XL, Ultra Multitemp	134TV
P-26-00103-02CRM	Optima	91TV

ALSO AVAILABLE PRE-TIER I ENGINES (PRE 1999)

Engine, Reman (134TV) Ultra

Order Part #: P-26-50004-00RM
(Replaces Carrier #: 26-50004-00RM)

Engine, Reman (134DI) Ultima

Order Part #: P-26-50015-00RM
(Replaces Carrier #: 26-50015-00RM)

✓ **We replace the following parts with new components:**

- Water Pump
- Oil Pump
- Bearings
- Pistons and Rings
- Glow Plugs
- Gaskets
- Seals

✓ **Each Engine is Dyno Tested:**

- Computer controls ensure that each engine Dyno Test is conducted under standard, repeatable settings
- Maximum torque and horsepower tested
- Black light leak tested with dyed oil and fuel

Carrier Engine Reference

TIER	YEAR STARTED	SERIAL # BEGINS
Tier I	1999	X
Tier II	2004	4A
Tier 4i	2008	8A

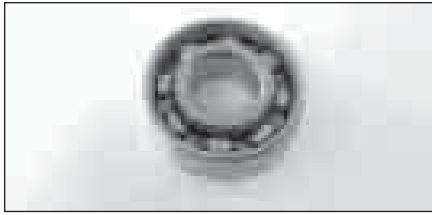

**Bearing, Fuel Cam (Rear)
91TV & 69TV**

Order Part #: P-25-15166-00
(Replaces Carrier #: 25-15166-00)

37TV, 44TV, & 29TV

Order Part #: P-25-34232-00
(Replaces Carrier #: 25-34232-00)

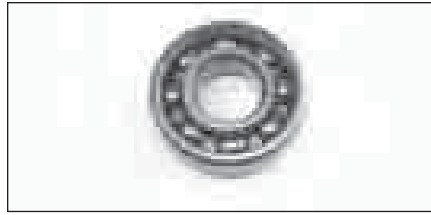

**Bearing, Fuel Cam (Front)
91TV & 69TV**

Order Part #: P-25-15167-00
(Replaces Carrier #: 25-15167-00)

37TV, 44TV, & 29TV

Order Part #: P-25-34227-00
(Replaces Carrier #: 25-34227-00)



**Bearing, Rod
134TV/DI**

133DI

114TV/DI

Standard

Order Part #: P-25-39122-00-B
(Replaces Carrier #: 25-39122-00)

-0.2MM

Order Part #: P-25-38122-01-B
(Replaces Carrier #: 25-38122-01)

-0.4MM

Order Part #: P-25-38122-02-B
(Replaces Carrier #: 25-38122-02)

114IDI

Standard

Order Part #: P-25-37384-04-B
(Replaces Carrier #: 25-37384-04)

-0.2MM

Order Part #: P-25-37407-00-B
(Replaces Carrier #: 25-37407-00)

-0.4MM

Order Part #: P-25-37408-00-B
(Replaces Carrier #: 25-37408-00)

114IDI

91TV & 69TV

Standard

Order Part #: P-25-15133-00-B
(Replaces Carrier #: 25-15133-00)

44TV & 29TV

Standard

Order Part #: P-25-34386-00-B
(Replaces Carrier #: 25-34386-00)

-0.2MM

Order Part #: P-25-34386-02-B
(Replaces Carrier #: 25-34386-02)

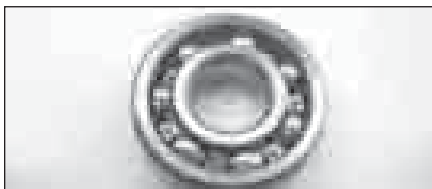

**Bearing, Governor Shaft
69TV & 91TV**

Order Part #: P-25-15181-00
(Replaces Carrier #: 25-15181-00)



Bushing, Govenor

Order Part #: P-25-15008-00
(Replaces Carrier #: 25-15008-00)

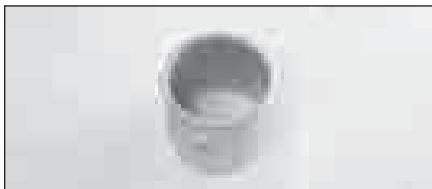

**Bushing, Piston Pin
134/TV/DI, 133DI
114TV/DI/IDI**

Order Part #: P-25-38121-00-B
(Replaces Carrier #: 25-38121-00)

91TV & 69TV

Order Part #: P-25-15131-00
(Replaces Carrier #: 25-15131-00)

44TV & 29TV

Order Part #: P-25-34384-00
(Replaces Carrier #: 25-34384-00)

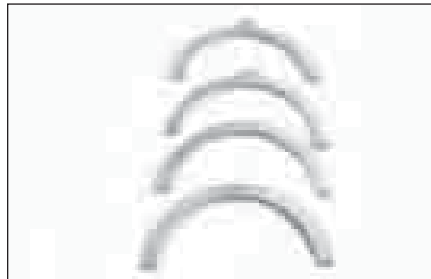

**Washer, Thrust (Std)
114TV/DI/IDI, 133DI
& 134TV/DI**

Order Part #: P-25-37399-00-B
(Replaces Carrier #: 25-37399-00)



**Washer Kit, Thrust (Std)
44TV & 29TV**

Order Part #: P-25-36430-00-B
(Replaces Carrier #: 25-36430-00)

Truck & Trailer Parts – ENGINE

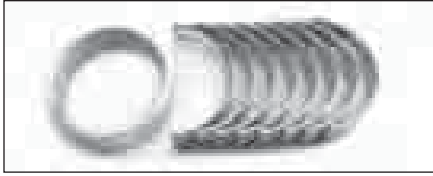

Bearing Set, Main #1-#5 134TV/DI, 133DI & 114TV/DI

-0.2MM
Order Part #: P-25-38126-01-B
(Replaces Carrier #: 25-38126-01)

-0.4MM
Order Part #: P-25-38126-02-B
(Replaces Carrier #: 25-38126-02)



Bearing, Main #1(Std) 134TV/DI, 133DI & 114TV/DI

Order Part #: P-25-39120-00-B
(Replaces Carrier #: 25-39120-00)

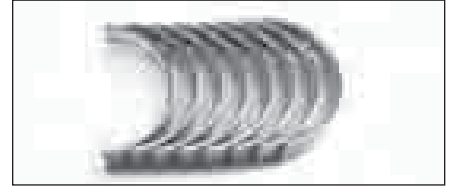

Bearing, Main #2-#5 (Std) 134TV/DI, 133DI & 114TV/DI

Order Part #: P-25-39121-00-B
(Replaces Carrier #: 25-39121-00)

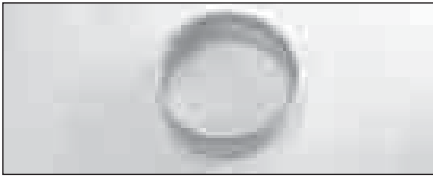

Bearing, #1 Main 91TV & 69TV

Standard
Order Part #: P-25-15145-00-B
(Replaces Carrier #: 25-15145-00)

44TV & 29TV
Standard
Order Part #: P-25-34171-00-B
(Replaces Carrier #: 25-34171-00)

-0.2MM (Also 37TV -0.2MM)
Order Part #: P-25-34389-02-B
(Replaces Carrier #: 25-34389-02)

-0.4MM
Order Part #: P-25-34389-04-B
(Replaces Carrier #: 25-34389-04)



Bearing, #2 Main 91TV & 69TV

Standard
Order Part #: P-25-15148-00-B
(Replaces Carrier #: 25-15148-00)

44TV & 29TV
Standard
Order Part #: P-25-34390-00-B
(Replaces Carrier #: 25-34390-00)

-0.2MM (Also 37 @ -0.2MM)
Order Part #: P-25-36428-01-B
(Replaces Carrier #: 25-36428-01)

-0.4MM (Also 37 @ -0.4MM)
Order Part #: P-25-34390-04-B
(Replaces Carrier #: 25-34390-04)



Bearing, #3 Main 91TV & 69TV

Standard
Order Part #: P-25-15151-00-B
(Replaces Carrier #: 25-15151-00)

-0.2MM
Order Part #: P-25-15151-02-B
(Replaces Carrier #: 25-15151-02)

44TV & 29TV
Standard
Order Part #: P-25-36428-00-B
(Replaces Carrier #: 25-36428-00)

-0.2MM (Also 37 @ -0.2MM)
Order Part #: P-25-34390-02-B
(Replaces Carrier #: 25-34390-02)

-0.4MM (Also 37 @ -0.4MM)
Order Part #: P-25-34391-04-B
(Replaces Carrier #: 25-34391-04)



Cap, Coolant Bottle

Order Part #: P-58-00743-00
(Replaces Carrier #: 58-00743-00)



Cap, Rain

Order Part #: 11-2916
(Replaces Carrier #: 30-00210-00)



Cap, Radiator

Order Part #: P-30-00397-00
(Replaces Carrier #: 30-00397-00)

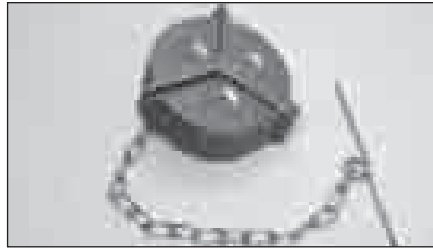

Cap, Fuel

Order Part #: P-44-00046-08
(Replaces Carrier #: 44-00046-08)



Dipstick

Order Part #: P-25-37085-00
(Replaces Carrier #: 25-37085-00)

How To Order Engine Overhaul Kits:

We show over 20 PG engine overhaul kits on this and the next two pages. Their Part #s are tailored to identify specific piston and bearing sizes as described in the example below. Overhaul kits other than the ones listed in this section can be created by your local Thermo King dealer. Just tell their parts department what engine and then specify piston and bearing sizes as below.

Ordering Example:

If you need a CT3-44TV Major Overhaul Kit with Standard Pistons, Second undersize Main Bearings and First undersize Rod Bearings, you would order:
P-44TV-S21

P-44TV- X X X

Piston
Code Here
Standard = S
+0.5mm = 1

Main Bearing
Code here
Standard = S
-0.2MM = 1
-0.4mm = 2

Rod Bearing
Code Here
Standard = S
-0.2mm = 1
-0.4mm = 2

FOR MAJOR OVERHAULS, the kits on this and the following pages have all the parts you need in one box.

FOR MINOR OVERHAULS, the kits include the same high-quality parts, however they do not include:

- Water Pump
- Oil Pump
- Glow Plugs
- Oil Pressure Switch
- Water Return Hose

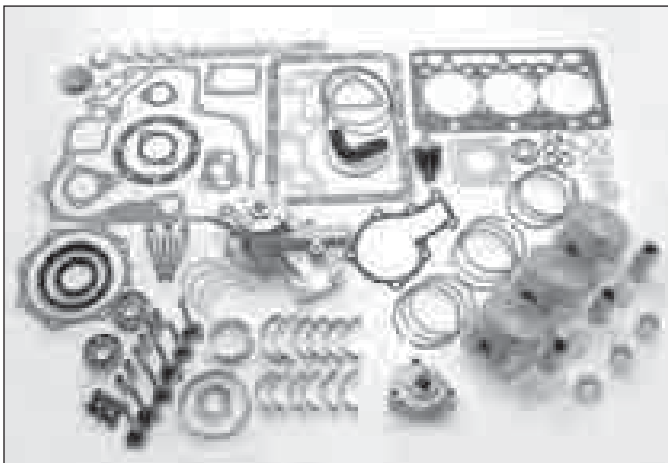

Eng O'haul Kit MAJOR (44TV)

Order Part #: P-44TV-1SS-B

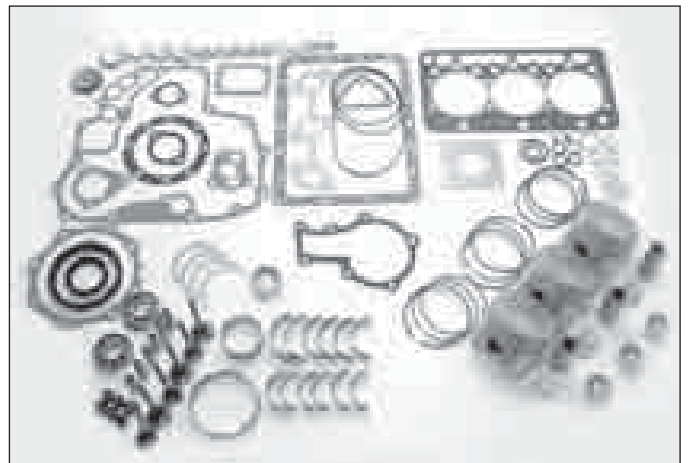

Eng O'haul Kit, MINOR (44TV)

Order Part #: P-44TV-M-1SS-B

Order Part #: P-44TV-M-SSS-B

Truck & Trailer Parts – ENGINE

ENGINE

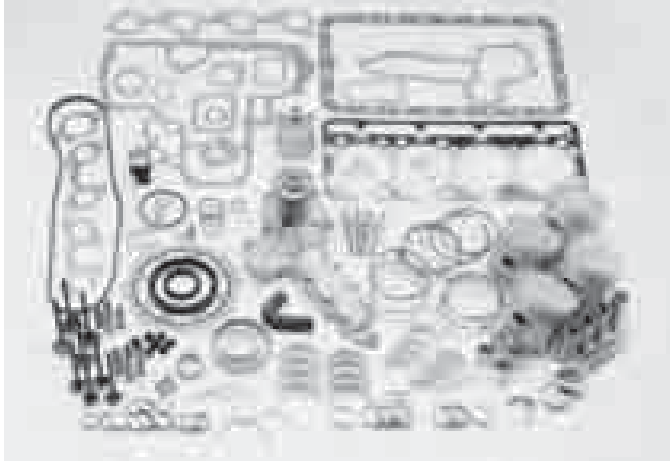

Eng O'haul Kit (134TV)

Order Part #: P-134TV-SSS

Order Part #: P-134TV-1SS

Order Part #: P-134TV-111

Order Part #: P-134TV-121

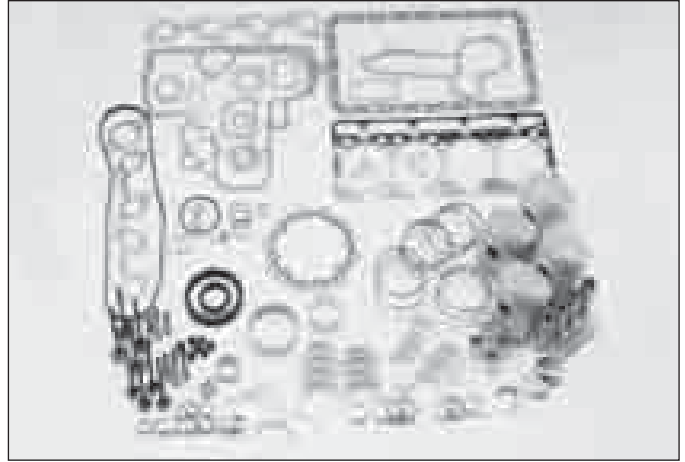

Eng O'haul Kit, Minor (134TV)

Order Part #: P-134TV-M-111

Order Part #: P-134TV-M-1SS

Order Part #: P-134TV-M-SSS

REMEMBER, ALL MAJOR KITS INCLUDE:

- Water Pump
- Oil Pump
- Oil Pressure Switch
- Glow Plugs
- Water return hose

MINOR KITS DO NOT include those 5 items.

SPECIAL NOTE: If you're rebuilding either a CT4-134TV or CT4-134DI engine that has a 2 PIECE OIL PAN you need to order the Supplement Gasket Set, Part # P-25-39007-01.

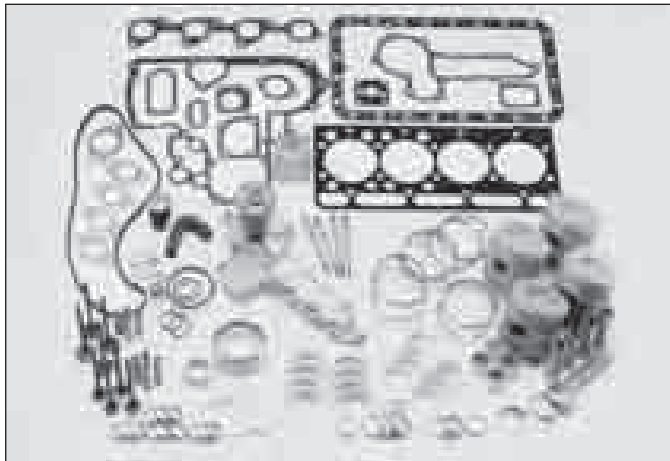

Engine Kit, Major (134DI)

Order Part #: P-134DI-111

Order Part #: P-134DI-1SS

Order Part #: P-134DI-SSS

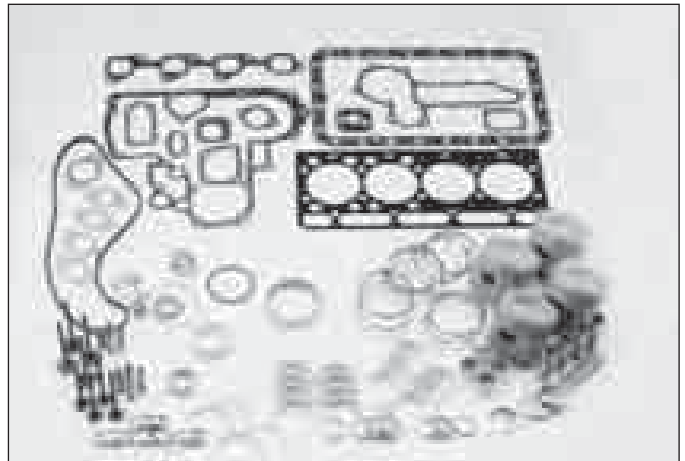

Eng O'haul Kit, Minor (134DI)

Order Part #: P-134DI-M-1SS

Order Part #: P-134DI-M-111

REMEMBER, ALL MAJOR KITS INCLUDE:

- Water Pump
- Oil Pump
- Oil Pressure Switch
- Glow Plugs
- Water return hose

MINOR KITS DO NOT include those 5 items.

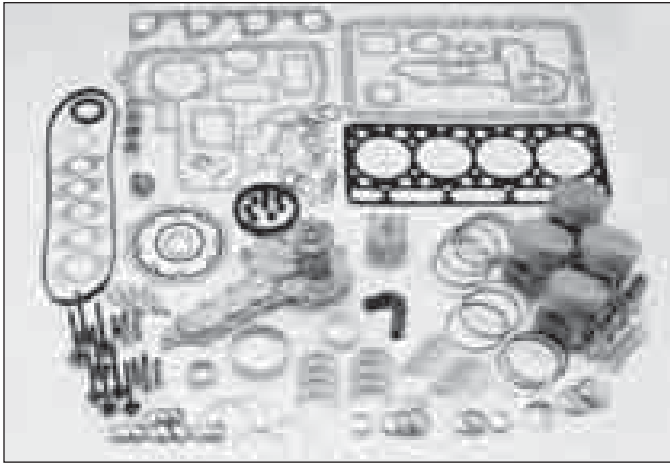

Eng O'haul Kit, (114)

- Order Part #: P-114-111
- Order Part #: P-114-1SS
- Order Part #: P-114-SSS

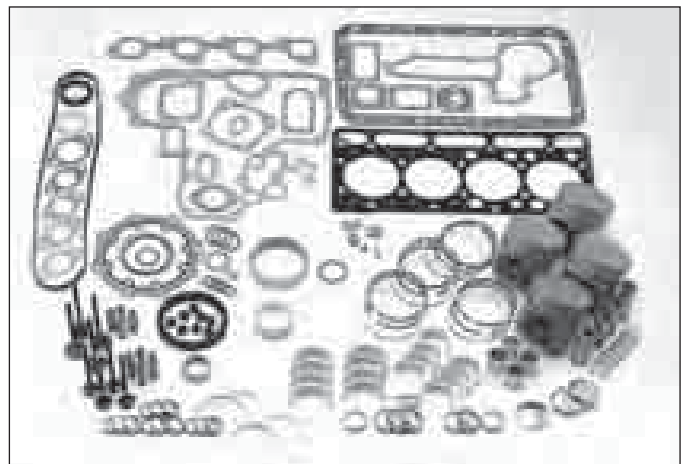

Eng O'haul Kit, Minor (114)

- Order Part #: P-114-M-1SS
- Order Part #: P-114-M-SSS
- Order Part #: P-114-M-111

REMEMBER, ALL MAJOR KITS INCLUDE:
• Water Pump • Oil Pump • Oil Pressure Switch
• Glow Plugs • Water return hose
MINOR KITS DO NOT include those 5 items.

SPECIAL NOTE: If you're rebuilding a CT4-114TV engine that has a 2 PIECE OIL PAN you need to order the Supplement Gasket Set, Part # P-25-39007-01.



Eng O'haul Kit, Major (114TV)

- Order Part #: P-114TV-111
- Order Part #: P-114TV-SSS
- Order Part #: P-114TV-1SS



Eng O'haul Kit, Minor (114TV)

- Order Part #: P-114TV-M-1SS
- Order Part #: P-114TV-M-SSS

REMEMBER, ALL MAJOR KITS INCLUDE:
• Water Pump • Oil Pump • Oil Pressure Switch
• Glow Plugs • Water return hose
MINOR KITS DO NOT include those 5 items.

Truck & Trailer Parts – ENGINE

ENGINE

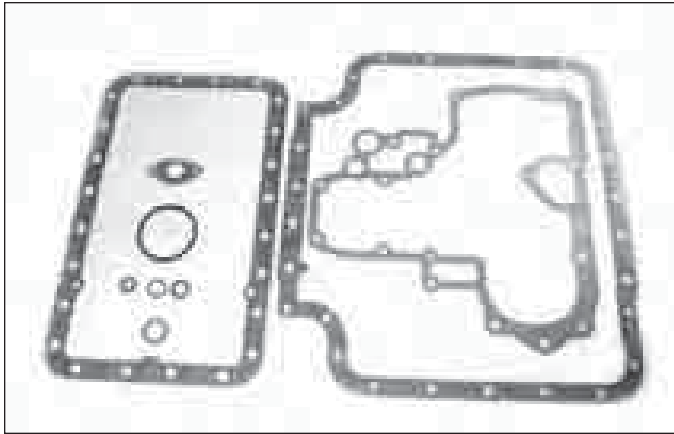

Gasket Set, TV Ultra Supplement

Order Part #: P-25-39007-01
 (Replaces Carrier #: 25-39007-01)

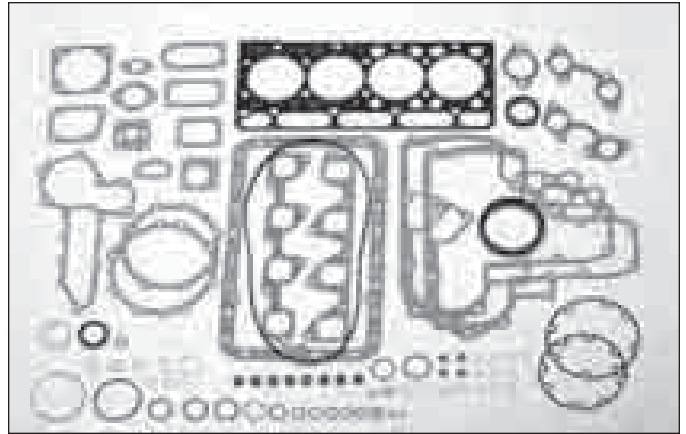

Gasket Set (134DI & 133DI)

Order Part #: P-25-38513-00
 (Replaces Carrier #: 25-38513-00)

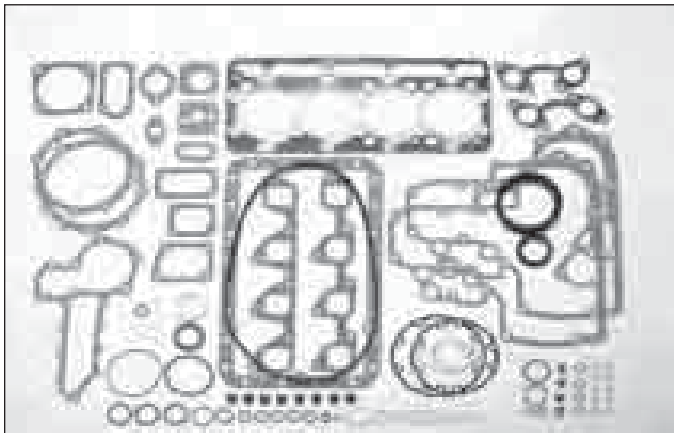

Gasket Set (134TV)

Order Part #: P-25-39006-00
 (Replaces Carrier #: 25-39006-00)

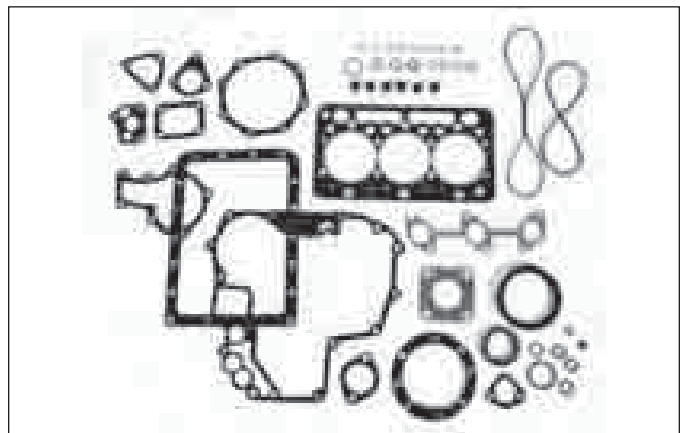

Gasket Set (44TV)

Order Part #: P-25-34023-00
 (Replaces Carrier #: 25-34023-00)

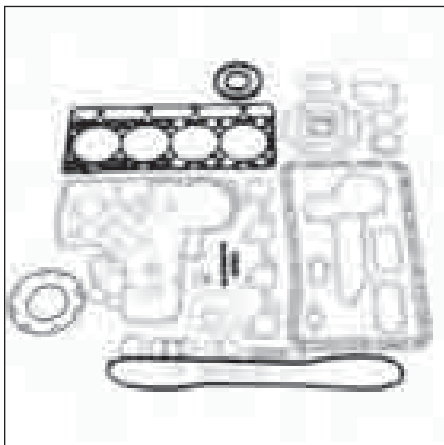

Gasket Set (114DI)

Order Part #: P-25-38010-00
 (Replaces Carrier #: 25-38010-00)

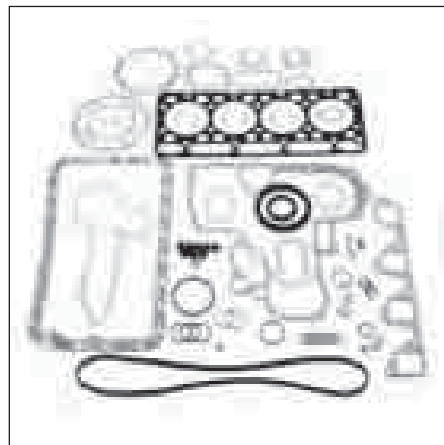

Gasket Set (114)

Order Part #: P-25-37016-00
 (Replaces Carrier #: 25-37016-00)

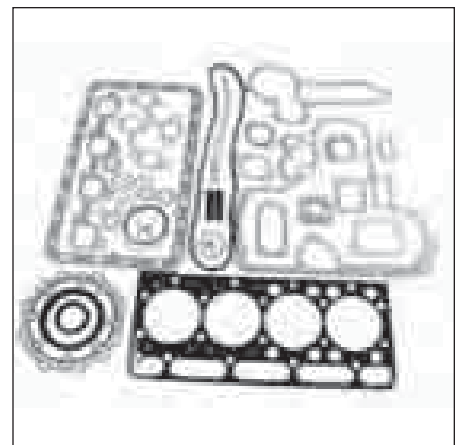

Gasket Set (114TV)

Order Part #: P-25-39008-00
 (Replaces Carrier #: 25-39008-00)

MASTER FILTER CROSS REFERENCE

MODEL	FILTER TYPE	THERMO KING PART #
ADVANTAGE	Filter, Air (Dry Type)	P-66U1-2155
	Filter, Fuel (Secondary)	P-30-00302-00
	Filter, Fuel (Fuel/Water Separator)	P-30-50301-01
	Filter, Oil (Bypass)	P-30-00304-00-B
	Filter, Oil – Full Flow	P-30-00323-00
EAGLE	Filter, Air (Dry Type)	P-66U1-2155
	Filter, Fuel (Secondary)	P-30-00302-00
	Filter, Fuel (Primary)	P-30-50301-01
	Filter, Oil (Bypass)	P-30-00304-00-B
	Filter, Oil (Full Flow)	P-30-00323-00
EXTRA	Filter, Air (Dry Type)	P-30-00430-23
	Filter, Fuel	P-30-01090-05
	Filter, Fuel	P-30-01079-01
	Filter, Fuel Pump (70 Micron)	P-30-01080-20
	Filter, Oil (Bypass)	P-30-00304-00-B
	Filter, Oil (Full Flow)	P-30-00323-00
EXTRA XT	Filter, Air (Primary) (XT Prior to SN LAA90946117)	P-30-00426-20
	Filter, Air (Primary) (XT SN LAA90946117 & After)	P-30-00471-20
	Filter, Fuel (XT)	P-30-01090-05
	Filter, Fuel Pump (70 Micron)	P-30-01080-20
	Filter, Oil (Primary)	P-30-00450-00
	Filter, Oil (Bypass)	P-30-00304-00-B
EUROPHOENIX	Filter, Fuel (Secondary)	P-30-00302-00
GENESIS TM900/1000	Filter, Air (Dry Type)	P-30-01077-01
	Filter, Fuel	P-30-01079-01
	Filter, Fuel Pump (70 Micron)	P-30-01080-20
	Filter, Oil (Bypass)	P-30-00304-00-B
	Filter, Oil (Full Flow)	P-30-00323-00
GENESIS Multi-Temp TM900/1000 (SN HAD90547903 thru NAY90594028)	Filter, Air (Dry Type)	P-30-00430-23
	Filter, Fuel	P-30-01079-01
	Filter, Fuel (Bowl Not Required)	P-30-01090-05
	Filter, Oil (Full Flow)	P-30-00323-00
	Filter, Oil (Bypass)	P-30-00304-00-B
GENESIS TR1000	Filter, Air (Primary)	P-30-00426-20
	Filter, Oil – Full Flow	P-30-00323-00
	Filter, Oil (Bypass)	P-30-00304-00-B
MAXIMA	Filter, Fuel	P-30-00302-00
	Filter, Fuel Pump (70 Micron)	P-30-01080-20
	Filter, Oil	P-30-50327-00
OPTIMA	Filter, Air (Dry Type)	P-30-00430-23
	Filter, Fuel	P-30-01079-01
	Filter (70 Micron) Fuel Pump	P-30-01080-20
	Filter, Oil (By-Pass)	P-30-00304-00-B
GENESIS R70	Filter, Air	P-30-60049-20
	Filter, Fuel (Secondary)	P-30-00302-00
	Filter, Fuel Pump (70 Micron)	P-30-01080-20
	Filter, Oil (Primary)	P-941172

CONTINUED NEXT PAGE

Truck & Trailer Parts – ENGINE

ENGINE

MASTER FILTER CROSS REFERENCE (continued)

MODEL	FILTER TYPE	THERMO KING PART #
GENESIS R90	Filter, Air (New)	P-30-60049-20
	Filter, Air (Dry Type) (Old)	P-25-35250-02
	Filter, Fuel	P-30-00302-00
	Filter Fuel Pump (70 Micron)	P-30-01080-20
	Filter, Oil (Full Flow)	P-30-00323-00
THUNDERBIRD	Filter, Air (Dry Type)	P-66U1-2155
	Filter, Fuel (Secondary)	P-30-00302-00
	Filter, Fuel (Primary)	P-30-50301-01
	Filter, Oil (Bypass)	P-30-00304-00-B
	Filter, Oil (Full Flow)	P-30-00323-00
ULTIMA	Filter, Air (Starting w/SN FAR90427529)	P-30-00430-23
	Filter, Air	P-30-01077-01
	Filter, Fuel (Bowl Not Required)	P-30-01090-05
	Filter, Fuel	P-30-01079-01
	Filter, Fuel Pump (70 Micron)	P-30-01080-20
	Filter, Oil (Bypass)	P-30-00304-00-B
	Filter, Oil (Full Flow)	P-30-00323-00
ULTIMA XTC	Filter, Air (ESI)	P-30-00426-27
	Filter, Air (Primary) (XT SN LAA90946117 & After)	P-30-00471-20
	Filter, Fuel (Bowl Not Required)	P-30-01090-05
	Filter, Fuel	P-30-01079-01
	Filter, Oil (ESI Primary)	P-30-00463-00
	Filter, Oil (Primary)	P-30-00450-00
ULTRA and ULTRA XL	Filter, Air (Dry Type)	P-30-01077-01
	Filter, Fuel	P-30-01079-01
	Filter, Fuel (XL) Prior to SN DAW90273677	P-30-01079-01
	Filter, Oil (Bypass)	P-30-00304-00-B
	Filter, Oil (Full Flow)	P-30-00323-00
ULTRA XT	Filter, Air (Primary) (XT, Prior to SN LAA90946117)	P-30-00426-20
	Filter, Air (Primary) (XT, SN LAA90946117 & After)	P-30-00471-20
	Filter, Fuel (Primary)	P-30-01090-05
	Filter, Fuel Pump (70 Micron)	P-30-01080-20
	Filter, Oil (Primary)	P-30-00450-00
ULTRA XTC	Filter, Air (ESI)	P-30-00426-27
	Filter, Air (Primary) (XT SN LAA90946117 & After)	P-30-00471-20
	Filter, Fuel (Primary)	P-30-01090-05
	Filter, Oil (ESI Primary)	P-30-00463-00
	Filter, Oil (Primary)	P-30-00450-00
SUPRA 922/944	Filter, Air (New)	P-30-60049-20
	Filter, Air (Dry Type) (Old)	P-25-35250-02
	Filter, Fuel (w/out Heater) (Starting w/SN EFY90375766)	P-30-01090-05
	Filter, Fuel (Used w/Water Sep.) (Prior to SN EFY90375766)	P-30-01079-01
	Filter, Fuel	P-30-00302-00
	Filter, Fuel Pump (70 Micron)	P-30-01080-20
	Filter, Oil (Full Flow)	P-30-00323-00

MASTER FILTER CROSS REFERENCE (continued)

MODEL	FILTER TYPE	THERMO KING PART #
SUPRA 844 and SUPRA 850	Filter, Air	P-30-60049-20
	Filter, Fuel (Bowl Not Required)	P-30-01090-05
	Filter, Fuel	P-30-01079-01
	Filter, Fuel Pump (70 Micron)	P-30-01080-20
	Filter, Oil – Bypass	P-30-00304-00-B
	Filter, Oil (Primary)	P-941172
SUPRA 722/744 and SUPRA 622/644	Filter, Fuel (Used w/Water Sep.)	P-30-01079-01
	Filter, Fuel (w/out heater)	P-30-01090-05
	Filter, Fuel Pump (70 Micron)	P-30-01080-20
	Filter, Oil (Bypass)	P-30-00304-00-B
	Filter, Oil – Full Flow, Model 1999 (N.A.O.)	P-30-00323-00
	Filter, Oil	P-941172
SUPRA 422	Filter, Fuel	P-30-01090-05
	Filter, Fuel (Used w/Water Sep.)	P-30-01079-01
	Filter, Fuel Pump (70 Micron)	P-30-01080-20
	Filter, Oil (By-Pass)	P-30-00304-00-B
	Filter, Oil	P-941172
SUPRA 550 and SUPRA 650/750	Filter, Air	P-30-60049-20
	Filter, Fuel (Bowl Not Required)	P-30-01090-05
	Filter, Fuel	P-30-01079-01
	Filter, Fuel Pump (80 Micron)	10-376
	Filter, Oil – Bypass	P-30-00304-00-B
	Filter, Oil (Primary)	P-941172
SUPRA 950	Filter, Air	P-30-60049-20
	Filter, Fuel	P-30-01079-01
	Filter, Fuel (Bowl Not Required)	P-30-01090-05
	Filter, Fuel Pump (80 Micron)	10-376
	Filter, Oil (Primary)	P-30-00323-00
SOLARA	Filter, Fuel	P-30-01079-01
	Filter, Fuel Pump (70 Micron)	P-30-01080-20

NOTE: For Oil and Fuel Filters as singles, add an S to the part number (i.e. P-30-00463-00S). Air Filters are sold as singles.

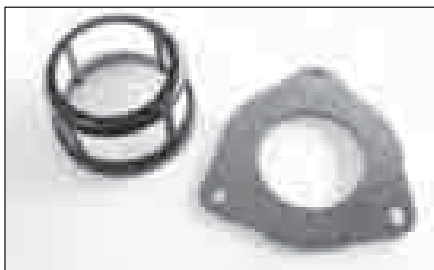

**Filter, Fuel Pump (Electric)
(70 Micron)**

Order Part #: P-30-01080-20
(Replaces Carrier #: 30-01080-20)



Filter, Air

Order Part #: P-30-00430-23
(Replaces Carrier #: 30-00430-23)



Filter, Air

Order Part #: P-30-01077-01
(Replaces Carrier #: 30-01077-01)

Truck & Trailer Parts – ENGINE

ENGINE



Filter, Air (ESI)

Order Part #: P-30-00426-27
(Replaces Carrier #: 30-00426-27)

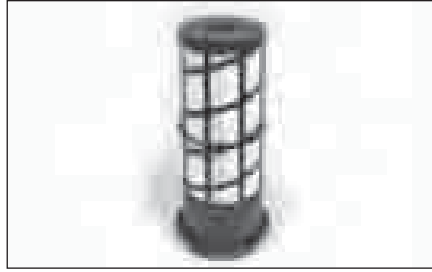

Filter, Air (Primary) XT, XTC

Order Part #: P-30-00426-20
(Replaces Carrier #: 30-00426-20)

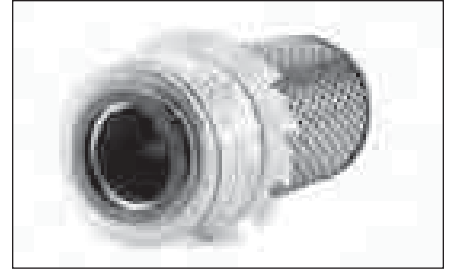

Filter, Air (Dry Type)

Order Part #: P-25-35250-02
(Replaces Carrier #: 25-35250-02)

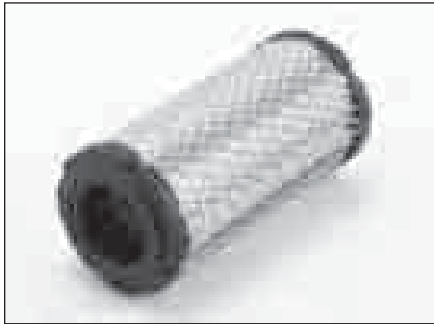

Filter, Air

Order Part #: P-30-60049-20
(Replaces Carrier #: 30-60049-20)

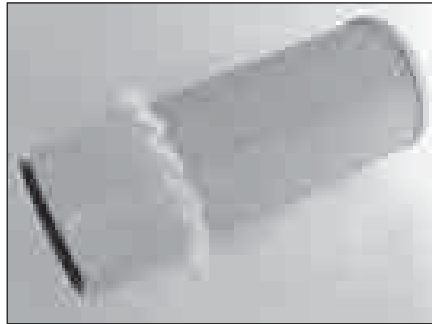

Filter, Air (Dry Type)

Order Part #: P-66U1-2155
(Replaces Carrier #: 66U1-2155)



Filter, Air

(Serial # LAA90946117 & Beyond)
Order Part #: P-30-00471-20
(Replaces Carrier #: 30-00471-20)



Filter, Oil

Order Part #: P-30-00323-00
(Replaces Carrier #: 30-00323-00)



Filter, Oil (ESI Primary XTC)

Order Part #: P-30-00463-00
(Replaces Carrier #: 30-00463-00)



Drain Cock

Order Part #: P-25-37593-00
(Replaces Carrier #: 25-37593-00)



80 Micron Fuel Pump Filter
Order Part #: 10-376

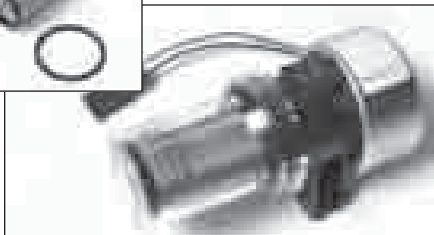

Fuel Pump Assembly

Order Part #: 41-7059
(Replaces Carrier #: 30-01108-01SV)

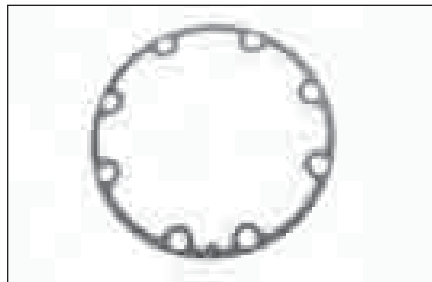

Gasket, Bearing

Order Part #: P-25-37195-01
(Replaces Carrier #: 25-37195-01)

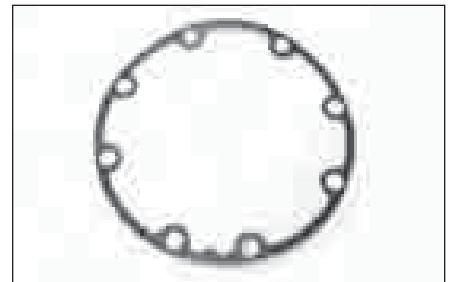

Gasket, Bearing

Order Part #: P-25-38557-00-B
(Replaces Carrier #: 25-38557-00)

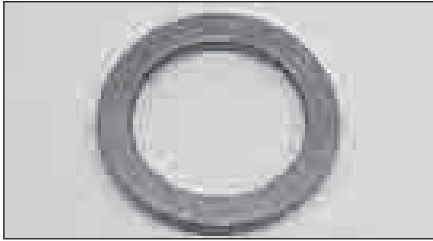

Gasket, Copper

Order Part #: 55-2208
(Replaces Carrier #: 25-38666-13)

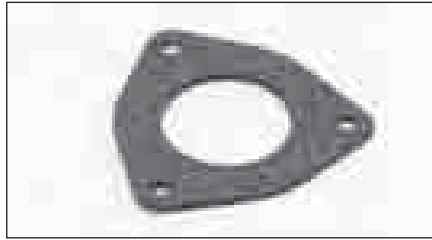

Gasket, Cover

Order Part #: P-30-01044-21
(Replaces Carrier #: 30-01044-21)

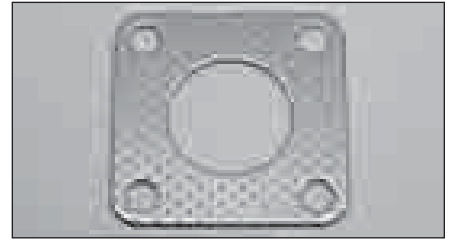

Gasket, Exhaust

Order Part #: P-25-33020-00
(Replaces Carrier #: 25-33020-00)

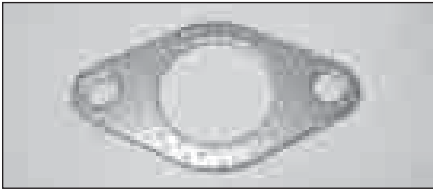

Gasket, Exhaust Manifold

Order Part #: P-25-37236-01
(Replaces Carrier #: 25-37236-01)

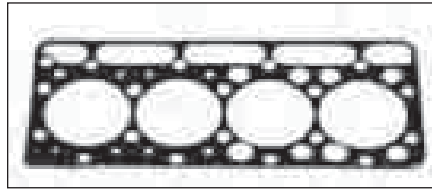

Gasket, Head (CT4-114)

Order Part #: P-25-37115-04-B
(Replaces Carrier #: 25-37115-04)

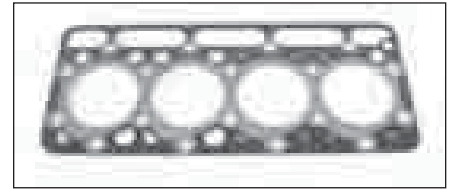

Gasket, Head (CT4-114TV)

Order Part #: P-25-39113-00-B
(Replaces Carrier #: 25-39113-00)

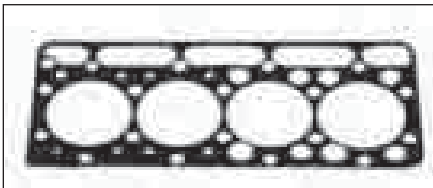

Gasket, Head (CT4-134DI)

Order Part #: P-25-38529-01-B
(Replaces Carrier #: 25-38529-01)



Gasket, Head (CT4-134TV)

Order Part #: P-25-38532-00-B
(Replaces Carrier #: 25-38532-00)



Gasket, Head Cover

Order Part #: P-25-37307-00-B
(Replaces Carrier #: 25-37307-00)



Gasket, Injector

Order Part #: P-25-34216-00
(Replaces Carrier #: 25-34216-00)



Gasket, Manifold

Order Part #: P-25-38076-00-B
(Replaces Carrier #: 25-38076-00)



Gasket, Muffler

Order Part #: P-25-37238-00-B
(Replaces Carrier #: 25-37238-00)



Gasket, Valve Cover (134DI)

Order Part #: P-25-38713-00
(Replaces Carrier #: 25-38713-00)

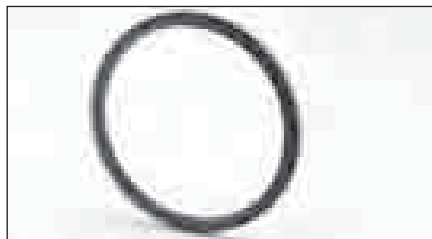

Gear, Ring

Order Part #: P-25-37420-12
(Replaces Carrier #: 25-37420-12)

Truck & Trailer Parts – ENGINE

ENGINE

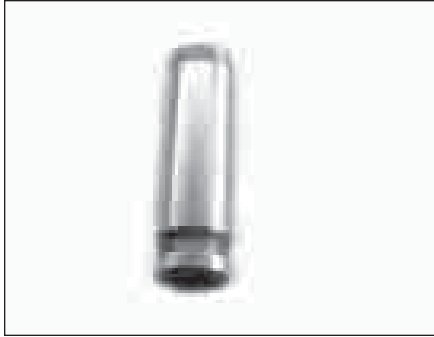

Guide, Exhaust Valve

Order Part #: P-25-34039-00-B
(Replaces Carrier #: 25-34039-00)

Guide, Exhaust Valve

Order Part #: P-25-39037-00-B
(Replaces Carrier #: 25-39037-00)



Guide, Intake Valve

Order Part #: P-25-39036-00
(Replaces Carrier #: 25-39036-00)

Guide, Intake Valve

Order Part #: P-25-34038-00-B
(Replaces Carrier #: 25-34038-00)



Hose, Air (Dry Type)

Order Part #: P-58-04157-00
(Replaces Carrier #: 58-04157-00)



Valve, Intake

Order Part #: P-25-15460-00
(Replaces Carrier #: 25-15460-00)

Valve, Intake

Order Part #: P-25-34110-00-B
(Replaces Carrier #: 25-34110-00)

Valve, Intake

Order Part #: P-25-37260-00-B
(Replaces Carrier #: 25-37260-00)

Valve, Intake

Order Part #: P-25-38085-00-B
(Replaces Carrier #: 25-38085-00)

Valve, Intake

Order Part #: P-25-39085-00-B
(Replaces Carrier #: 25-39085-00)



Valve, Exhaust

Order Part #: P-25-34111-00-B
(Replaces Carrier #: 25-34111-00)

Valve, Exhaust

Order Part #: P-25-37261-00-B
(Replaces Carrier #: 25-37261-00)

Valve, Exhaust

Order Part #: P-25-38086-00-B
(Replaces Carrier #: 25-38086-00)

Valve, Exhaust

Order Part #: P-25-39086-00-B
(Replaces Carrier #: 25-39086-00)



Hose, Air

Order Part #: P-58-60090-00
(Replaces Carrier #: 58-60090-00)



Hose, Air (Dry Type)

Order Part #: P-58-04074-00
(Replaces Carrier #: 58-04074-00)



Hose, Coolant

Order Part #: P-58-60039-19
(Replaces Carrier #: 58-60039-19)

HOSES BY MODEL

Thermo King #	Description	Carrier #
ADVANTAGE		
P-58-00659-00	Hose, Fuel 3/16 25'	58-00659-00
P-58-00904-00	Hose, Radiator (Fill)	58-00904-00
P-58-00903-00	Hose, Radiator (Inlet, Upper)	58-00903-00
P-58-00801-00	Hose, Radiator (Outlet, Lower)	58-00801-00
P-58-00902-02	Hose, Radiator (Outlet, Upper)	58-00902-02
EAGLE		
P-58-00253-00	Hose, Drain (Condensate)	58-00253-00
P-58-00659-00	Hose, Fuel 3/16 25'	58-00659-00
P-58-00922-00	Hose, Radiator (Inlet)	58-00922-00
P-58-00921-00	Hose, Radiator (Outlet)	58-00921-00
EUROPHOENIX		
P-58-00659-00	Hose, Fuel 3/16 25'	58-00659-00
EXTRA		
P-58-04074-00	Hose, Air (Dry Type)	58-04074-00
P-58-00253-00	Hose, Drain (Condensate)	58-00253-00
P-58-00659-00	Hose, Fuel 3/16 25'	58-00659-00
P-58-04080-00	Hose, Radiator (Inlet, Upper)	58-04080-00
P-58-04079-00	Hose, Radiator (Outlet, Lower)	58-04079-00
GENESIS		
P-58-00659-00	Hose, Fuel 3/16 25'	58-00659-00
MAXIMA		
P-58-00659-00	Hose, Fuel 3/16 25'	58-00659-00
P-25-15411-00	Hose, Water Return	25-15411-00
OPTIMA		
P-58-04157-00	Hose, Air (Dry Type)	58-04157-00
P-58-00253-00	Hose, Drain (Condensate)	58-00253-00
P-58-00659-00	Hose, Fuel 3/16 25'	58-00659-00
P-58-04155-00	Hose, Radiator (Inlet, Upper)	58-04155-00
P-25-15411-00	Hose, Water Return	25-15411-00
THUNDERBIRD		
P-58-00253-00	Hose, Drain (Condensate)	58-00253-00
P-58-00659-00	Hose, Fuel 3/16 25'	58-00659-00
P-58-00904-00	Hose, Radiator (Fill)	58-00904-00
P-58-00903-00	Hose, Radiator (Inlet, Upper)	58-00903-00
P-58-00801-00	Hose, Radiator (Outlet, Lower)	58-00801-00
P-58-00902-02	Hose, Radiator (Outlet, Upper)	58-00902-02

(continued next page)



Hose, Drain (Condensate)

Order Part #: P-58-00253-00
(Replaces Carrier #: 58-00253-00)

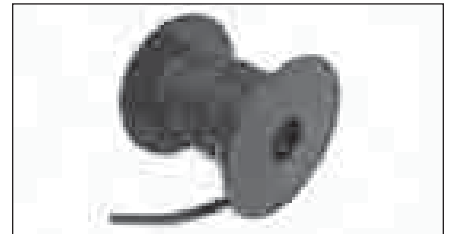

Hose, Fuel 3/16 25'

Order Part #: P-58-00659-00
(Replaces Carrier #: 58-00659-00)

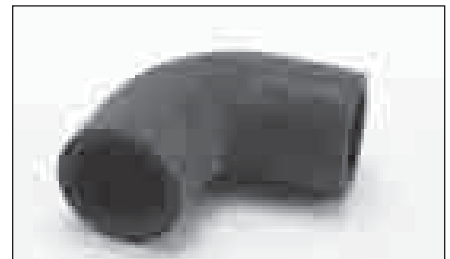

Hose, Formed (AIR)

Order Part #: P-58-04203-01
(Replaces Carrier #: 58-04203-01)

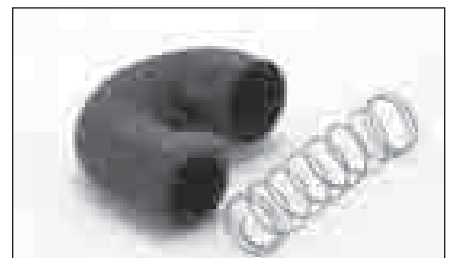

Hose, Formed (AIR)

Order Part #: P-58-00976-00
(Replaces Carrier #: 58-00976-00)

Truck & Trailer Parts – ENGINE

ENGINE

HOSES BY MODEL – Con't

Thermo King #	Description	Carrier #
ULTIMA		
P-58-00253-00	Hose, Drain (Condensate)	58-00253-00
P-58-00659-00	Hose, Fuel 3/16 25'	58-00659-00
P-58-01317-00	Hose, Radiator (Outlet, Lower)	58-01317-00
P-58-04223-04	Hose, Radiator (Outlet, Upper)	58-04223-04
ULTRA		
P-58-04074-00	Hose, Air (Dry Type)	58-04074-00
P-58-00253-00	Hose, Drain (Condensate)	58-00253-00
P-58-00659-00	Hose, Fuel 3/16 25'	58-00659-00
P-58-04080-00	Hose, Radiator (Inlet, Upper)	58-04080-00
P-58-04079-00	Hose, Radiator (Outlet, Lower)	58-04079-00
VATNA		
P-58-00659-00	Hose, Fuel 3/16 25'	58-00659-00
VECTOR		
P-58-00659-00	Hose, Fuel 3/16 25'	58-00659-00
SUPRA 922/944		
P-58-60039-19	Hose, Coolant	58-60039-19
P-58-00659-00	Hose, Fuel 3/16 25'	58-00659-00
P-58-60039-00	Hose, Radiator	58-60039-00
P-58-60189-00	Hose, Radiator (Lower)	58-60189-00
P-58-60039-15	Hose, Upper Radiator	58-60039-15
P-25-15411-00	Hose, Water Return	25-15411-00

(continued next page)



Hose, Formed (ENG TO RAD)

Order Part #: P-58-04216-00
(Replaces Carrier #: 58-04216-00)

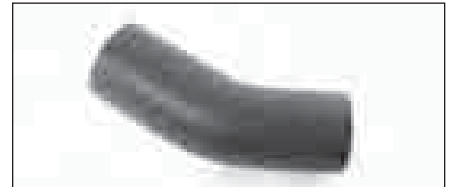

Hose, Radiator (Fill)

Order Part #: P-58-00904-00
(Replaces Carrier #: 58-00904-00)



Hose, Radiator (Inlet, Upper)

Order Part #: P-58-04080-00
(Replaces Carrier #: 58-04080-00)



Hose, Radiator

Order Part #: P-58-60039-00
(Replaces Carrier #: 58-60039-00)



Hose, Lower Radiator

Order Part #: P-58-60039-21
(Replaces Carrier #: 58-60039-21)

HOSES BY MODEL – Con't

Thermo King #	Description	Carrier #
SUPRA 844		
P-58-00659-00	Hose, Fuel 3/16 25'	58-00659-00
SUPRA 722/744 & Supra 622/644		
P-58-60090-00	Hose, Air	58-60090-00
P-58-00659-00	Hose, Fuel 3/16 25'	58-00659-00
P-58-60039-21	Hose, Lower Radiator	58-60039-21
P-58-60002-00	Hose, Radiator (Upper)	58-60002-00
P-25-34329-00	Hose, Water Return	25-34329-00
SUPRA 550		
P-58-00659-00	Hose, Fuel 3/16 25'	58-00659-00
SUPRA 422		
P-58-00659-00	Hose, Fuel 3/16 25'	58-00659-00
P-58-60039-08	Hose, Radiator (Upper)	58-60039-08
P-25-34308-00	Hose, Water Return	25-34308-00

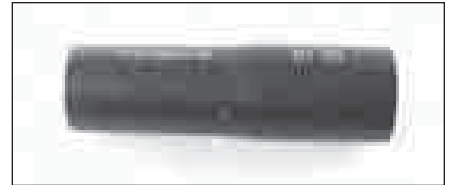

Hose, Radiator (Inlet, Upper)

Order Part #: P-58-00903-00
(Replaces Carrier #: 58-00903-00)



Hose, Radiator (Lower)

Order Part #: P-58-60189-00
(Replaces Carrier #: 58-60189-00)



Hose, Radiator (Inlet, Upper)

Order Part #: P-58-04155-00
(Replaces Carrier #: 58-04155-00)



Hose, Radiator (Inlet)

Order Part #: P-58-00922-00
(Replaces Carrier #: 58-00922-00)



Hose, Radiator (Outlet, Lower)

Order Part #: P-58-04079-00
(Replaces Carrier #: 58-04079-00)



Hose, Radiator (Outlet, Lower)

Order Part #: P-58-00801-00
(Replaces Carrier #: 58-00801-00)



Hose, Radiator (Outlet, Lower)

Order Part #: P-58-01317-00
(Replaces Carrier #: 58-01317-00)

Truck & Trailer Parts – ENGINE

ENGINE

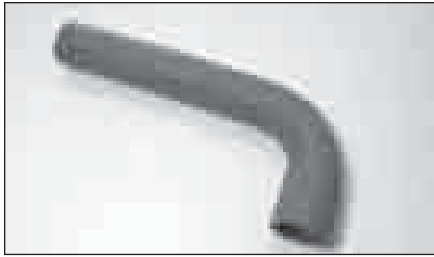

Hose, Radiator (Outlet, Upper)

Order Part #: P-58-00902-02
(Replaces Carrier #: 58-00902-02)

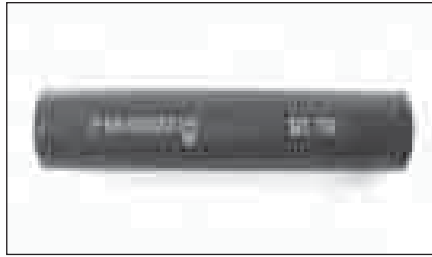

Hose, Radiator (Outlet, Upper)

Order Part #: P-58-04223-04
(Replaces Carrier #: 58-04223-04)



Hose, Radiator (Outlet)

Order Part #: P-58-00921-00
(Replaces Carrier #: 58-00921-00)

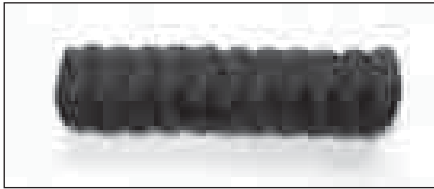

Hose, Radiator (Upper)

Order Part #: P-58-60002-00
(Replaces Carrier #: 58-60002-00)

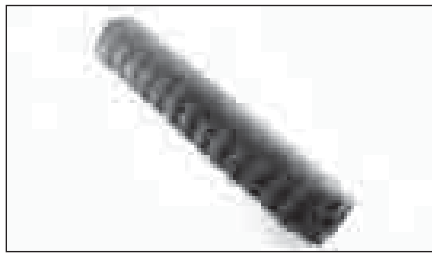

Hose, Radiator (Upper)

Order Part #: P-58-60039-08
(Replaces Carrier #: 58-60039-08)

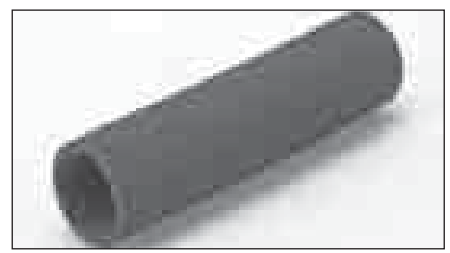

Hose, Upper Radiator

Order Part #: P-58-60039-15
(Replaces Carrier #: 58-60039-15)



Hose, Water Return

Order Part #: P-25-15411-00
(Replaces Carrier #: 25-15411-00)



Hose, Water Return

Order Part #: P-25-34308-00
(Replaces Carrier #: 25-34308-00)



Hose, Water Return

Order Part #: P-25-34329-00
(Replaces Carrier #: 25-34329-00)

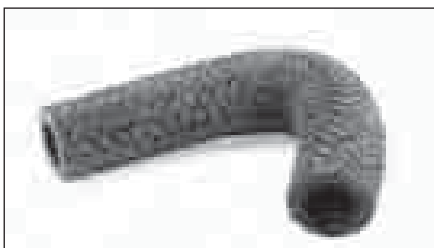

Tube, Water Return

Order Part #: P-25-37556-00
(Replaces Carrier #: 25-37556-00)



**Injector, Fuel (114IDI)
(w/o gasket or seal)**
Order Part #: P-25-37625-00
(Replaces Carrier #: 25-37625-00)



**Injector, Fuel (114DI)
(complete w/seal)**
Order Part #: P-25-38155-00
(Replaces Carrier #: 25-38155-00)



**Injector, Fuel
(134DI & 133DI)
(complete w/seal)**
Order Part #: P-25-38640-00
(Replaces Carrier #: 25-38640-00)



**Injector, Fuel (134TV)
(w/gasket & seal)**
Order Part #: P-25-39145-01-B
(Replaces Carrier #: 25-39145-01)



**Injector, Fuel (29TV & 44TV)
(w/o gasket or seal)**
Order Part #: P-25-34830-00SV
(Replaces Carrier #: 25-34830-00SV)



**Injector, Fuel (69TV & 91TV)
(w/o gasket or seal)**
Order Part #: P-25-15327-00SV
(Replaces Carrier #: 25-15327-00SV)

Fuel Injector Gaskets & Seals for 29TV, 44TV, 69TV, 91TV, & 134TV Engines



Gasket
Order Part #: P-25-34216-00
Replaces Carrier #: 25-34216+00

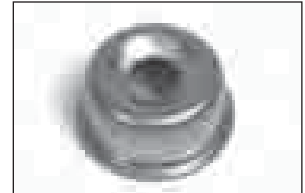

Seal
Order Part #: P-25-39147-00
Replaces Carrier #: 25-39147-00

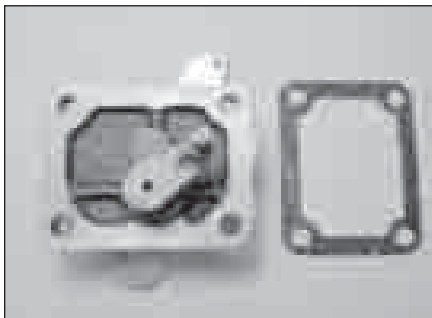

Lever, Engine Stop
Order Part #: P-25-38710-01
(Replaces Carrier #: 25-38710-01)



Lever, Speed Control
Order Part #: P-25-37503-00SV
(Replaces Carrier #: 25-37503-00SV)



Muffler
Order Part #: P-30-00401-06
(Replaces Carrier #: 30-00401-06)

Truck & Trailer Parts – ENGINE

ENGINE



Muffler

Order Part #: P-30-01087-00
(Replaces Carrier #: 30-01087-00)



Pipe, Lower Exhaust

Order Part #: P-30-00402-01
(Replaces Carrier #: 30-00402-01)



Pipe, Upper Exhaust

Order Part #: P-30-00402-05
(Replaces Carrier #: 30-00402-05)

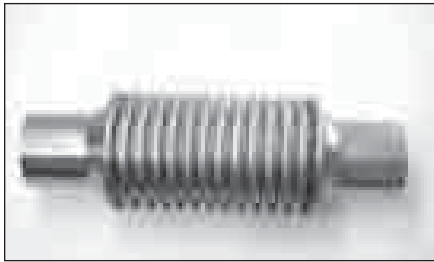

Pipe, Flex Exhaust

Order Part #: P-30-01237-00
(Replaces Carrier #: 30-01237-00)



O-Ring

Order Part #: P-25-34341-00
(Replaces Carrier #: 25-34341-00)



Piston Assy w/Rings (Std) (114TV)

Serial # prior to 1e
Order Part #: P-25-39117-01-B
(Replaces Carrier #: 25-39117-01)
(+0.5MM)
Order Part #: P-25-39117-03-B
(Replaces Carrier #: 25-39117-03)



Piston Assy w/Rings (Std) (114DI)

Order Part #: P-25-37417-00-B
(Replaces Carrier #: 25-37417-00)
(+ 0.5MM)
Order Part #: P-25-37417-05-B
(Replaces Carrier #: 25-37417-05)



Piston Assy w/o Rings (114DI) (Std)

Order Part #: P-25-38115-11
(Replaces Carrier #: 25-38115-11)
(+ 0.5MM)
Order Part #: P-25-38115-02
(Replaces Carrier #: 25-38115-02)

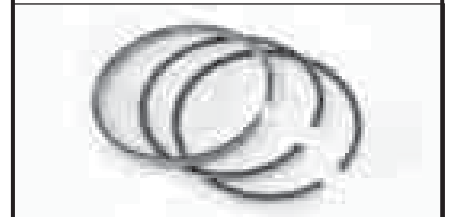

Ring Set, Piston (114TV) (Std)

Order Part #: P-25-39119-00-B
(Replaces Carrier #: 25-39119-00)
(+0.5MM)
Order Part #: P-25-39119-01-B
(Replaces Carrier #: 25-39119-01)



Ring Set, Piston 114DI/114IDI (Std)

Order Part #: P-25-37383-00-B
(Replaces Carrier #: 25-37383-00)
(+0.5MM)
Order Part #: P-25-37406-00-B
(Replaces Carrier #: 25-37406-00)



**Piston Assy w/o Rings
(Std) (134TV)**

(SN prior to 210389)
Order Part #: P-25-39110-01-B
(Replaces Carrier #: 25-39110-01)
(+ 0.5MM)
Order Part #: P-25-39110-03-B
(Replaces Carrier #: 25-39110-03)

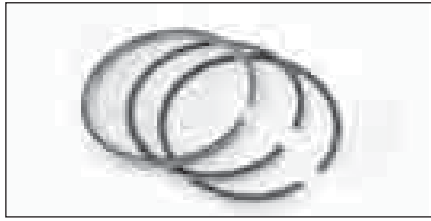

**Ring Set, Piston
(Std) (134TV/DI)**

Order Part #: P-25-38611-00
(Replaces Carrier #: 25-38611-00)
(+ 0.5MM)
Order Part #: P-25-38611-01-B
(Replaces Carrier #: 25-38611-01)



**Piston Assy w/o Rings
(Std) (134DI)**

Order Part #: P-25-39127-01-B
(Replaces Carrier #: 25-39127-01)
(+0.5MM)
Order Part #: P-25-39128-01-B
(Replaces Carrier #: 25-39128-01)



**Piston Assy w/Rings
(Std) (44TV/29TV)**

Order Part #: P-25-34380-00SVB
(Replaces Carrier #: 25-34380-00SV)
(+ 0.25MM)
Order Part #: P-25-34380-05SVB
(Replaces Carrier #: 25-34380-05SV)

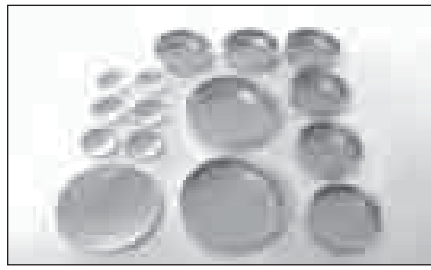

**Plug Set, Expansion
(Block)**

Order Part #: P-25-37020-00
(Replaces Carrier #: 25-37020-00)

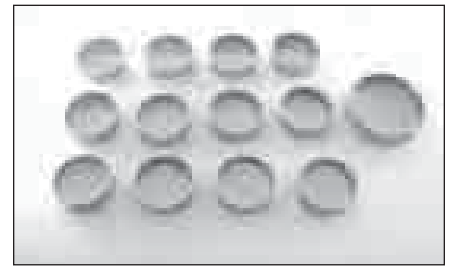

**Plug Set, Expansion
(Head)**

Order Part #: P-25-37021-00
(Replaces Carrier #: 25-37021-00)



**Ring Set, Piston
44TV/29TV (Std)**

Order Part #: P-25-34381-00
(Replaces Carrier #: 25-34381-00)
(+0.25MM)
Order Part #: P-25-34381-05-B
(Replaces Carrier #: 25-34381-05)



Plug, Fuel Cam

Order Part #: P-25-34018-00
(Replaces Carrier #: 25-34018-00)

See Next Page for More Expansion Plugs →

Truck & Trailer Parts – ENGINE

ENGINE

Plug, Expansion (Sold individually)

134TV/DI

133DI

114DI/IDI

Order Part #: P-25-37107-00

(Replaces Carrier #: 25-37107-00)

Order Part #: P-25-37032-00

(Replaces Carrier #: 25-37032-00)

Order Part #: P-25-37033-00

(Replaces Carrier #: 25-37033-00)

91TV

Order Part #: P-25-37107-00

(Replaces Carrier #: 25-37107-00)

Order Part #: P-25-15004-00

(Replaces Carrier #: 25-15004-00)

Order Part #: P-25-15006-00

(Replaces Carrier #: 25-15006-00)

Order Part #: P-25-34006-00

(Replaces Carrier #: 25-34006-00)

Order Part #: P-25-35077-00

(Replaces Carrier #: 25-35077-00)

Order Part #: P-25-35690-00

(Replaces Carrier #: 25-35690-00)

Order Part #: P-25-39015-00

(Replaces Carrier #: 25-39015-00)

69TV

Order Part #: P-25-37107-00

(Replaces Carrier #: 25-37107-00)

Order Part #: P-25-15004-00

(Replaces Carrier #: 25-15004-00)

Order Part #: P-25-34006-00

(Replaces Carrier #: 25-34006-00)

Order Part #: P-25-35077-00

(Replaces Carrier #: 25-35077-00)

Order Part #: P-25-35690-00

(Replaces Carrier #: 25-35690-00)

Order Part #: P-25-39015-00

(Replaces Carrier #: 25-39015-00)

44TV & 29TV

Order Part #: P-25-34006-00

(Replaces Carrier #: 25-34006-00)

Order Part #: P-25-34016-00

(Replaces Carrier #: 25-34016-00)

Order Part #: P-25-34017-00

(Replaces Carrier #: 25-34017-00)

Order Part #: P-25-35690-00

(Replaces Carrier #: 25-35690-00)

Order Part #: P-25-36027-01

(Replaces Carrier #: 25-36027-01)

37

Order Part #: P-25-34006-00

(Replaces Carrier #: 25-34006-00)

Order Part #: P-25-35690-00

(Replaces Carrier #: 25-35690-00)

Order Part #: P-25-36027-01

(Replaces Carrier #: 25-36027-01)

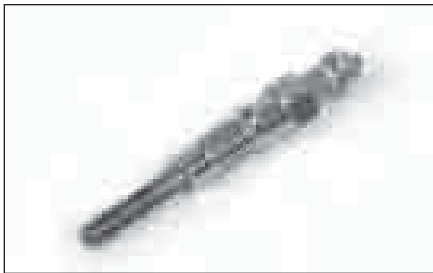

Plug, Glow (M10 Slow Glow) (91TV)

Order Part #: P-25-15325-00

(Replaces Carrier #: 25-15325-00)



Plug, Glow (114IDI & 114TV)

Order Part #: P-25-37614-10

(Replaces Carrier #: 25-37614-10)



Plug, Glow (44TV & 37)

Order Part #: P-25-36482-01

(Replaces Carrier #: 25-36482-01)

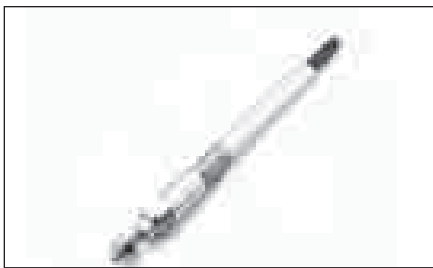

Plug, Glow (134DI, 114DI & 133DI)

Order Part #: P-25-38150-01-B

(Replaces Carrier #: 25-38150-01)



Plug, Glow (134TV and 114TV)

Order Part #: P-25-39155-00

(Replaces Carrier #: 25-39155-00)



Plug, Glow (44TV & 29TV)

Order Part #: P-7103921

(Replaces Carrier #: 7103921)

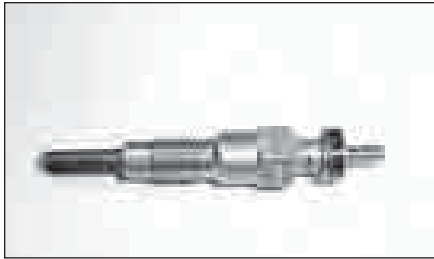

**Plug, Glow (M8 Fast Glow)
(91TV and 69TV)**
Order Part #: P-25-15330-00
(Replaces Carrier #: 25-15330-00)

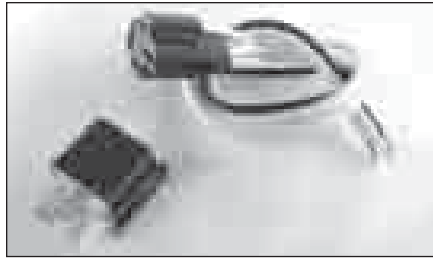

Glow Plug Kit
Order Part #: P-76-50033-00
(Replaces Carrier #: 76-50033-00)

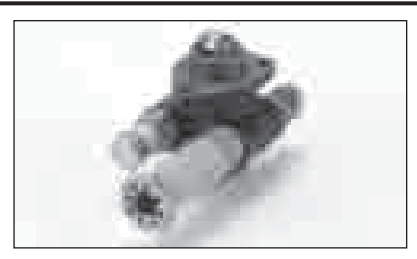

**Pump, Fuel Assembly
(Mechanical)**
Order Part #: P-25-38666-00
(Replaces Carrier #: 25-38666-00)

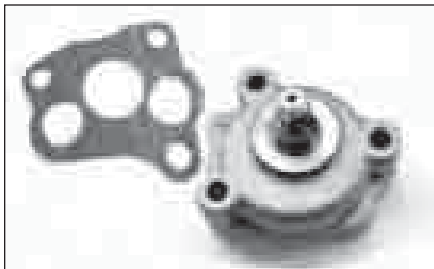

**Pump, Oil w/gasket
(29TV & 44TV)**
Order Part #: P-25-34021-00-B
(Replaces Carrier #: 25-34021-00)



**Gasket, Oil Pump
(29TV & 44TV)**
Order Part #: P-25-34022-00
(Replaces Carrier #: 25-34022-00)

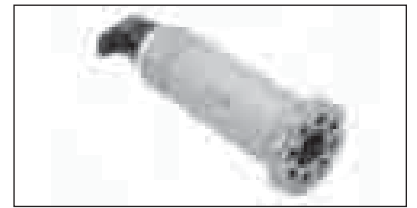

Pump, Priming
Order Part #: P-25-38666-11
(Replaces Carrier #: 25-38666-11)

Pump, O-Ring
Order Part #: P-25-38666-09
(Replaces Carrier #: 25-38666-09)



Pump, Oil
Order Part #: P-25-15040-00
(Replaces Carrier #: 25-15040-00)

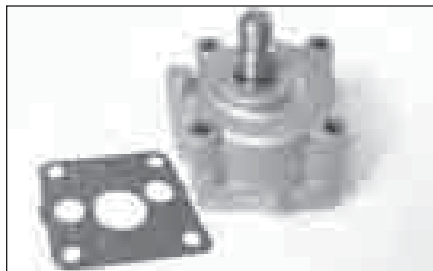

**Pump, Oil w/gasket
(CT4 engines, except 91)**
Order Part #: P-25-37040-00-B
(Replaces Carrier #: 25-37040-00)

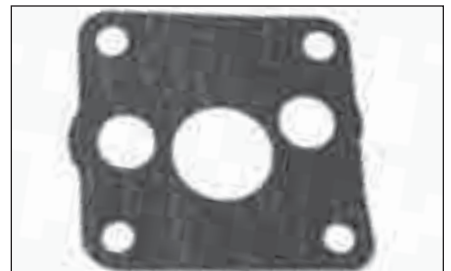

**Gasket, Oil Pump
(CT4 engines, except 91)**
Order Part #: P-25-37041-00
(Replaces Carrier #: 25-37041-00)

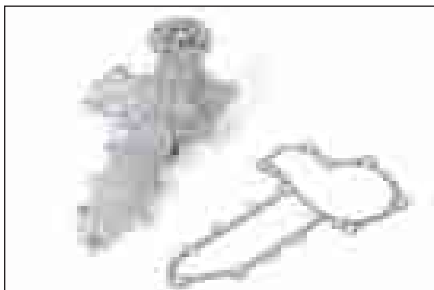

Pump, Water w/gasket (4i)
Order Part #: P-25-15568-00-SV
(Replaces Carrier #: 25-15568-00-SV)
Gasket, Water Pump (4i)
Order Part #: P-25-15569-00
(Replaces Carrier #: 25-15569-00)

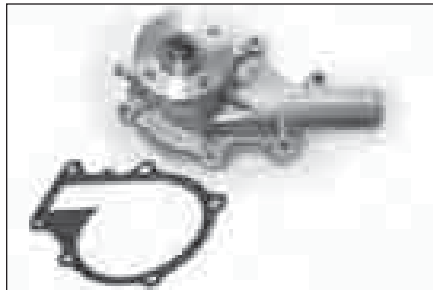

**Pump, Water w/gasket
(91TV)**
Order Part #: P-25-15425-00SV
(Replaces Carrier #: 25-15425-00SV)



**Gasket, Water Pump
(91TV)**
Order Part #: P-25-15426-00
(Replaces Carrier #: 25-15426-00)

Truck & Trailer Parts – ENGINE

ENGINE

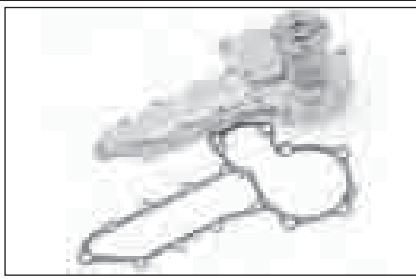

**Pump, Water w/gasket
(CT4 engines, except 91TV)**

Order Part #: P-25-37581-10-B
(Replaces Carrier #: 25-37581-10)

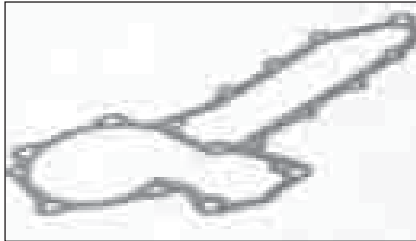

**Gasket, Water Pump
(CT4 engines, except 91TV)**

Order Part #: P-25-37574-00
(Replaces Carrier #: 25-37574-00)

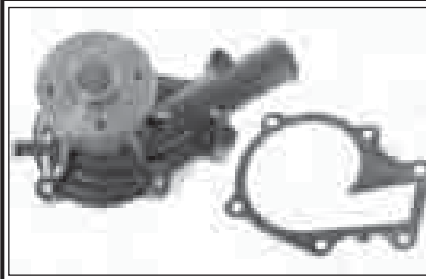

**Pump, Water w/gasket
(69TV)**

Order Part #: P-29-70183-00SVB
(Replaces Carrier #: 29-70183-00SV)



**Gasket, Water Pump
(69TV)**

Order Part #: P-29-70188-00
(Replaces Carrier #: 29-70188-00)

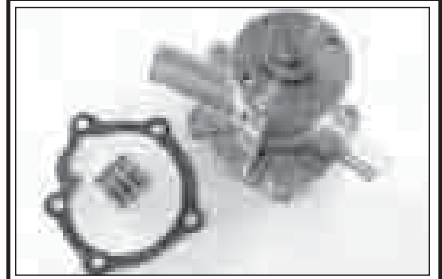

**Pump, Water w/gasket
(29TV)**

Order Part #: P-25-34935-00SV
(Replaces Carrier #: 25-34935-00SV)

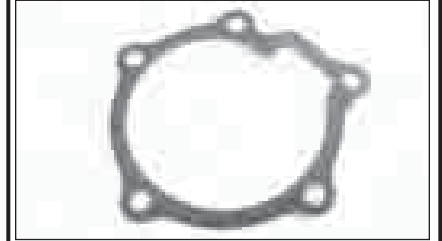

**Gasket, Water Pump
(29TV)**

Order Part #: P-25-34317-00
(Replaces Carrier #: 25-34317-00)



**Pump, Water w/gasket
(44TV)**

Order Part #: P-25-34330-00SVB
(Replaces Carrier #: 25-34330-00SV)



**Gasket, Water Pump
(44TV)**

Order Part #: P-25-34333-00
(Replaces Carrier #: 25-34333-00)



Starter

Order Part #: P-25-15520-00
(Replaces Carrier #: 25-15520-00)



Starter

Order Part #: P-25-35465-00
(Replaces Carrier #: 25-35465-00)



Starter

Order Part #: P-25-34885-00
(Replaces Carrier #: 25-34885-00)

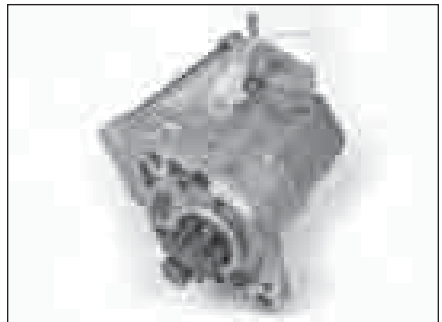

Starter (2.0 KW)

Order Part #: P-25-39291-00-B
(Replaces Carrier #: 25-39291-00)

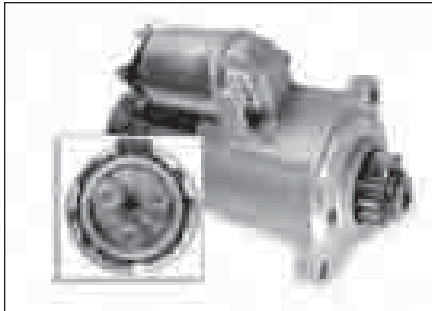

Starter (Planetary Gear Reduction)

Order Part #: P-25-38750-00PG
(Replaces Carrier #: 25-38750-00)

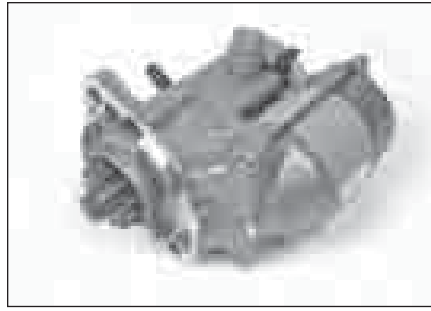

Starter, 1 pc Oil Pan

Order Part #: P-25-38750-00
(Replaces Carrier #: 25-38750-00)

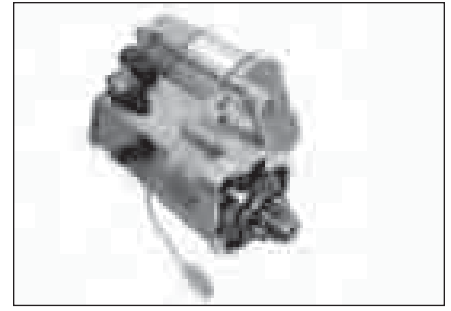

Starter

Order Part #: P-29-70158-00
(Replaces Carrier #: 29-70158-00)

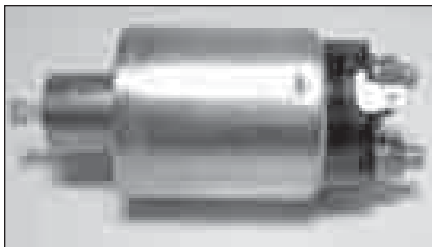

Solenoid, Starter

Order Part #: P-25-34893-00
(Replaces Carrier #: 25-34893-00)

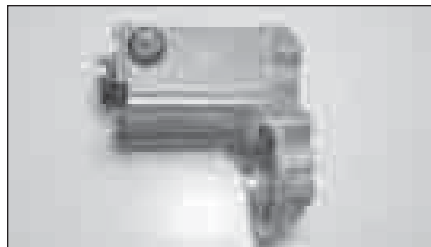

Solenoid, Starter

Order Part #: P-25-35466-00
(Replaces Carrier #: 25-35466-00)



Solenoid, Speed

Order Part #: P-10-01178-04SV
(Replaces Carrier #: 10-01178-04SV)



Solenoid, Speed

Order Part #: P-10-60018-00SVB
(Replaces Carrier #: 10-60018-00SV)



Solenoid, Speed

Order Part #: P-10-01179-00
(Replaces Carrier #: 10-01179-00)



Solenoid, Speed

Order Part #: P-10-01095-00-B
(Replaces Carrier #: 10-01095-00)



Boot Kit, Solenoid

Order Part #: P-10-01178-21
(Replaces Carrier #: 10-01178-21)



Boot, Solenoid

Order Part #: P-58-50006-00
(Replaces Carrier #: 58-50006-00)

Truck & Trailer Parts – ENGINE

ENGINE



Rod, Linkage Kit

Order Part #: P-73-00324-03SV
(Replaces Carrier #: 73-00324-03SV)



Clip, Speed (Left Side)

Order Part #: P-44-01049-01
(Replaces Carrier #: 44-01049-01)



Clip, Speed (Right Side)

Order Part #: P-44-01049-00
(Replaces Carrier #: 44-01049-00)



Rod, Linkage

Order Part #: P-73-00150-00
(Replaces Carrier #: 73-00150-00)

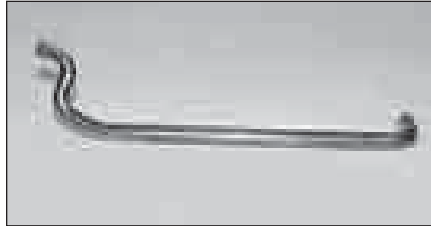

Rod, Stop Linkage

Order Part #: P-73-60004-00
(Replaces Carrier #: 73-60004-00)



Spring, Stop Control

Order Part #: P-73-60005-00
(Replaces Carrier #: 73-60005-00)



Rod

Order Part #: P-30-60031-01
(Replaces Carrier #: 30-60031-01)

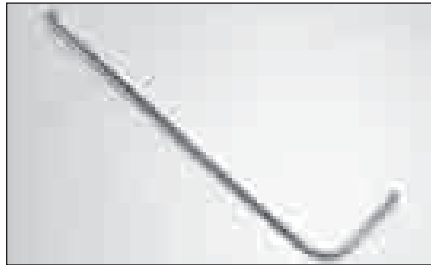

Rod

Order Part #: P-7102167
(Replaces Carrier #: 7102167)



Rod, Speed Control

Order Part #: P-30-60030-00
(Replaces Carrier #: 30-60030-00)



Rod, Linkage Speed

Order Part #: P-73-00333-00
(Replaces Carrier #: 73-00333-00)



Rod, Linkage Speed

Order Part #: P-73-00332-00
(Replaces Carrier #: 73-00332-00)



Rod, Linkage, Speed

Order Part #: P-73-00312-00
(Replaces Carrier #: 73-00312-00)



Rod

Order Part #: P-25-39112-00
(Replaces Carrier #: 25-39112-00)

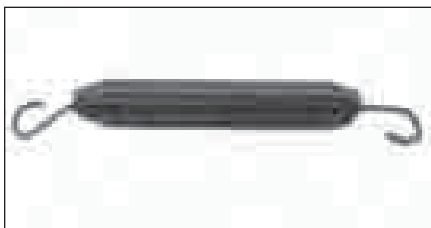

Spring

Order Part #: P-73-00145-01
(Replaces Carrier #: 73-00145-01)

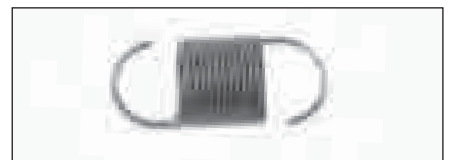

Spring, Start

Order Part #: P-29-70216-00
(Replaces Carrier #: 29-70216-00)

Truck & Trailer Parts – ENGINE

ENGINE

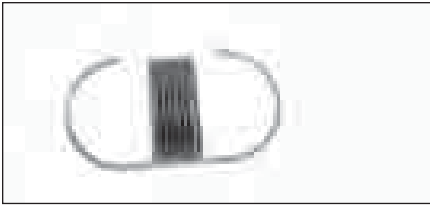

Spring, Start

Order Part #: P-25-34265-01
(Replaces Carrier #: 25-34265-01)



Spring, Governor

Order Part #: P-25-34275-00
(Replaces Carrier #: 25-34275-00)

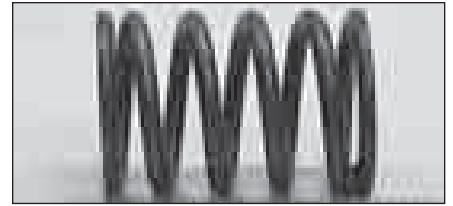

Spring, Valve

Order Part #: P-25-34112-00
(Replaces Carrier #: 25-34112-00)

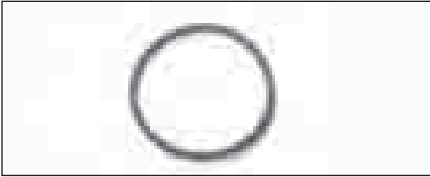

Seal, O-Ring

Order Part #: P-25-37599-00
(Replaces Carrier #: 25-37599-00)

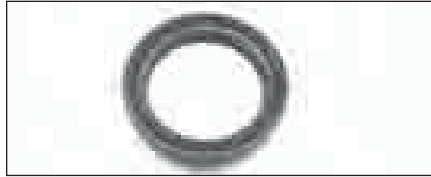

Seal, Oil

Order Part #: P-25-15055-00
(Replaces Carrier #: 25-15055-00)



Seal, Oil (Front)

Order Part #: P-25-34069-00-B
(Replaces Carrier #: 25-34069-00)

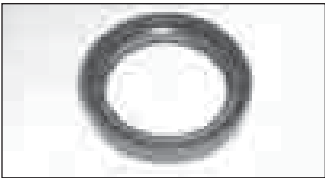

Seal, Oil (Front)

Order Part #: P-25-37396-01-B
(Replaces Carrier #: 25-37396-01)

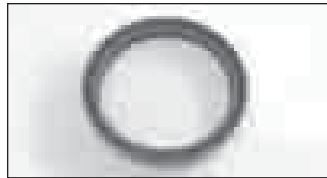

Seal, Oil (Rear)

Order Part #: P-25-37197-00-B
(Replaces Carrier #: 25-37197-00)

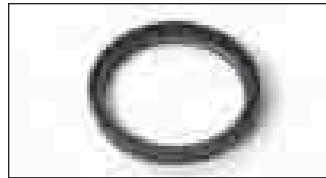

Seal, Oil (Rear)

Order Part #: P-25-35182-05
(Replaces Carrier #: 25-35182-05)

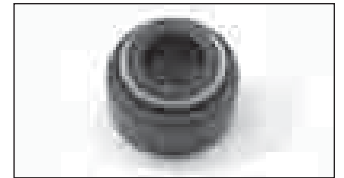

Seal, Valve Stem

Order Part #: P-25-15465-00-B
(Replaces Carrier #: 25-15465-00)



Seal, Valve Stem

Order Part #: P-25-37265-00
(Replaces Carrier #: 25-37265-00)



Sleeve, Wear (Front)

Order Part #: P-25-34173-00
(Replaces Carrier #: 25-34173-00)



Sleeve, Wear (Front)

Order Part #: P-25-37388-00-B
(Replaces Carrier #: 25-37388-00)



Sleeve, Wear (Rear)

Order Part #: P-25-15152-00
(Replaces Carrier #: 25-15152-00)



Sleeve, Wear (Rear)

Order Part #: P-25-37385-02-B
(Replaces Carrier #: 25-37382-02)



Sleeve, Wear

Order Part #: P-25-35420-11
(Replaces Carrier #: 25-35420-11)

Truck & Trailer Parts – ENGINE

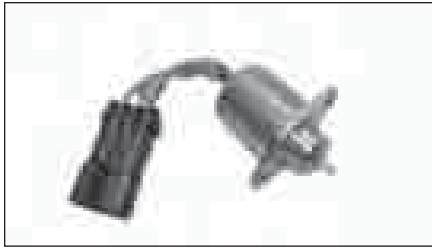

Solenoid, Fuel Shut Off (91TV/69TV)

Order Part #: P-25-15230-01
(Replaces Carrier #: 25-15230-01)



Solenoid, Injection Pump (2-piece oil pan)

Order Part #: P-25-38109-05SV
(Replaces Carrier #: 25-38109-05SV)

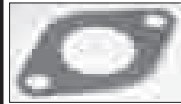

Gasket, Fuel Solenoid
Order Part #: P-25-39171-00
(Replaces Carrier #: 25-39171-00)

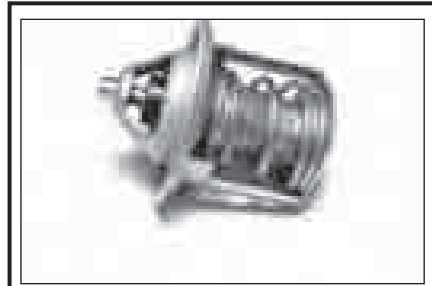

Thermostat, Water w/o gasket (29TV, 44TV, 69TV, 91TV)

Order Part #: P-25-34309-01
(Replaces Carrier #: 25-34309-01)

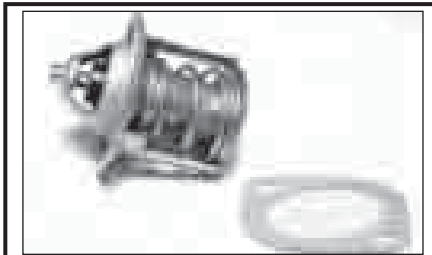

Thermostat, Water w/gasket (134TV & 114TV)

Order Part #: P-25-39236-01-B
(Replaces Carrier #: 25-39236-01)



Valve, Check Fuel

Order Part #: P-30-01105-00SV
(Replaces Carrier #: 30-01105-00SV)



Gasket, Thermostat (29TV, 44TV, 69TV, 91TV)

Order Part #: P-25-36676-00
(Replaces Carrier #: 25-36676-00)

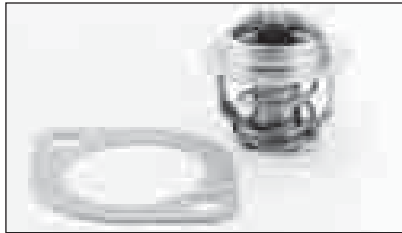

Thermostat, Water w/gasket (134DI, 114DI, 114IDI & 133DI)

Order Part #: P-25-37559-01
(Replaces Carrier #: 25-37559-01)



Washer

Order Part #: P-25-37589-00
(Replaces Carrier #: 25-37589-00)

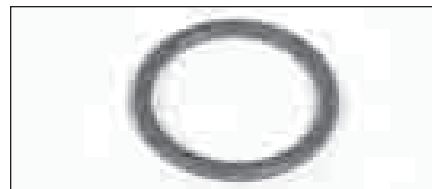

Washer, Oil Drain

Order Part #: P-25-36739-00
(Replaces Carrier #: 25-36739-00)



Gasket, Thermostat (All 4 Cyl except 91TV)

Order Part #: P-25-37558-00
(Replaces Carrier #: 25-37558-00)

Our PG Parts™ Remanufactured Engines and Compressors come with a 2-year Thermo King warranty backed by a nationwide dealer network

REMANUFACTURED COMPRESSORS

We offer a variety of Carrier compressors for your convenience. To determine the correct model you need, verify the model or part number on the Carrier compressor you are replacing. Carrier compressors come in a number of varieties, with some of the differences not being visually apparent, therefore, it is important for you to verify the model or part number required for your application.

NOTE: Compressors are furnished without oil. Installer must add the proper type and quantity of compressor oil compatible with the specific Carrier refrigeration system being serviced.

PG Parts Remanufactured Compressors:

- ✓ Our compressors are remanufactured in the same plant as our Genuine Thermo King compressors
- ✓ Each compressor features machined, resurfaced heads for optimal gasket sealing, resulting in longer service life and higher performance
- ✓ Our compressor cylinders are honed with an advanced honing machine to deliver higher capacity performance and reliability resulting in longer ring life and better life of the compressor
- ✓ Compressor specifications match Carrier OEM standards

The following models are available:

05G 41 CFM with unloaders	P-18-00059-72RM
05G 37 CFM ultra-flange	P-18-00059-126RM
05G 41CFM ultra-flange	P-18-00059-127RM
05G 37 CFM non-ultra flange	P-17-44063-00
05G 41 CFM non-ultra flange	P-17-44101-01
05G 37 CFM bus	P-17-44062-00
05G 41 CFM bus	P-17-44065-00
05G 37 CFM 922/944	P-18-00059-130RM
05K 24 CFM	P-18-00057-23RM
05K 12 CFM	P-18-60000-04RM

CARRIER 05G NOMENCLATURE

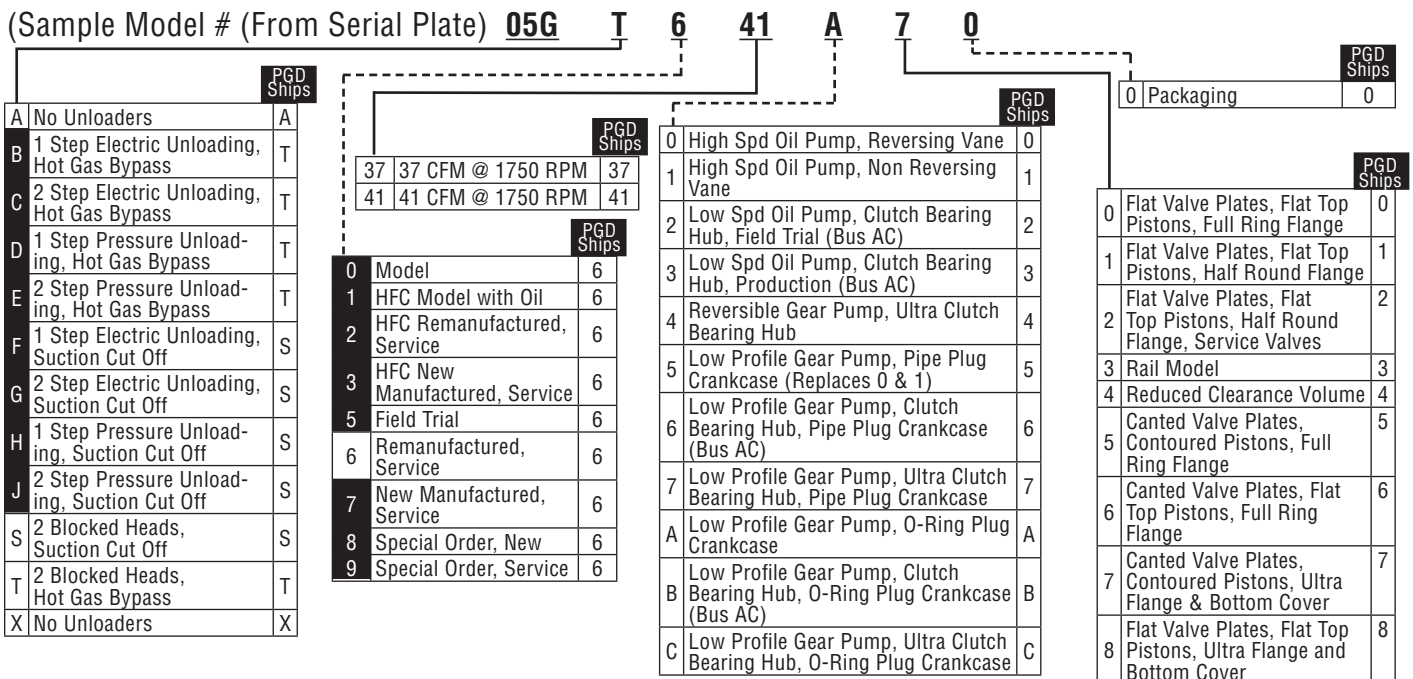

COMPRESSORS

COMPRESSOR

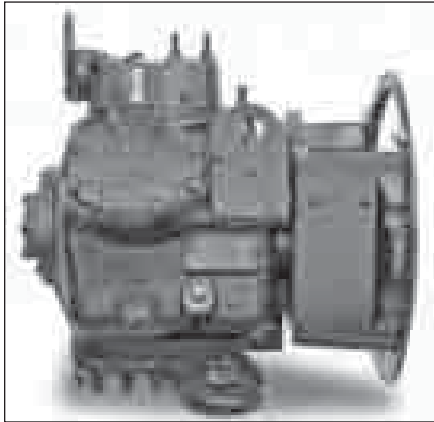

Compressor, Reman. w/Unloaders

Order Part #: P-18-00059-72RM
(Replaces Carrier #: 18-00059-72)

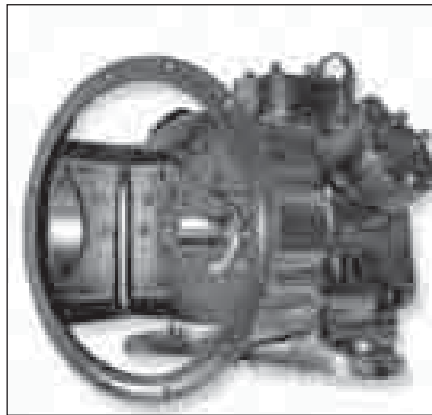

Compressor, Reman. (05G 37 CFM) Ultra

Order Part #: P-18-00059-126RM
(Replaces Carrier #: 18-00059-126)

Compressor, Reman. (05G 41 CFM) Ultra

Order Part #: P-18-00059-127RM
(Replaces Carrier #: 18-00059-127)

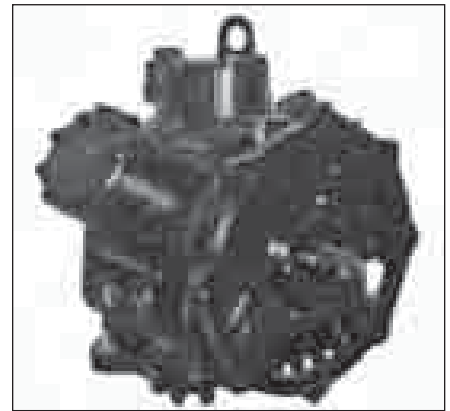

Compressor, Reman. (05G 37 CFM)

Order Part #: P-17-44063-00
(Replaces Carrier #: 17-44063-00)

Compressor, Reman. (05G 41 CFM)

Order Part #: P-17-44101-01
(Replaces Carrier #: 17-44101-01)

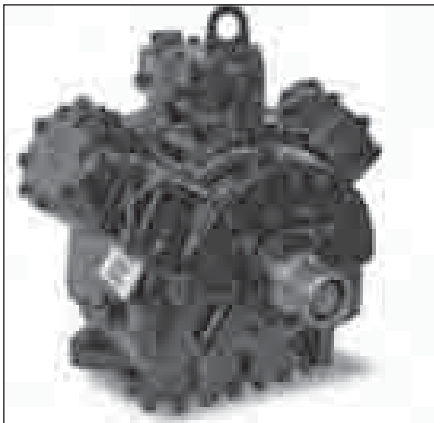

Compressor, Reman. Bus (05G 37 CFM)

Order Part #: P-17-44065-00
(Replaces Carrier #: 17-44065-00)

Compressor, Reman. Bus (05G 41 CFM)

Order Part #: P-17-44062-00
(Replaces Carrier #: 17-44062-00)

**Remanufactured
PG Parts™ Compressors
for your Carrier® units**

**We replace the following parts
with new components:**

- ✓ Valve
- ✓ All gaskets
- ✓ Oil Pump
- ✓ Thrust Washers
- ✓ Rods
- ✓ Valve plates
- ✓ Bearings
- ✓ Shaft seal
- ✓ Pistons
- ✓ Crankshaft*

* Replaced as new or remanufactured to OEM specification when necessary

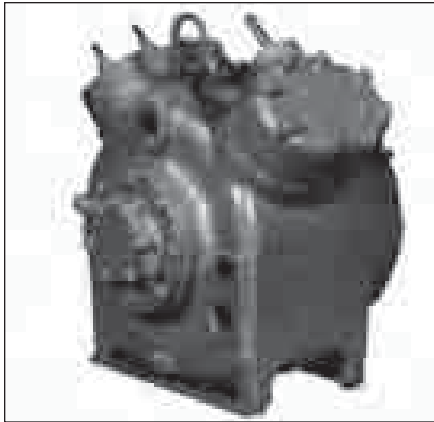

Compressor, Reman. (05K 24 CFM) Optima
 Order Part #: P-18-00057-23RM
 (Replaces Carrier #: 18-00057-23)

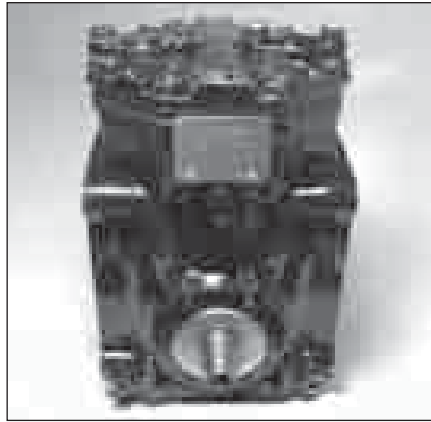

Compressor Kit Supra 4XX (NEW, not remanufactured)
 Order Part #: P-18-60002-03SV
 (Replaces Carrier #: 18-60002-03SV)



Return Kit

Covers Kit, 05G (Use to prep compressor for return)
 Order Part #: P-05G-COVERS
 (Replaces Carrier #: 05G-COVERS)



Compressor, Reman. (05G 37 CFM) 922/944
 Order Part #: P-18-00059-130RM
 (Replaces Carrier #: 18-00059-130)

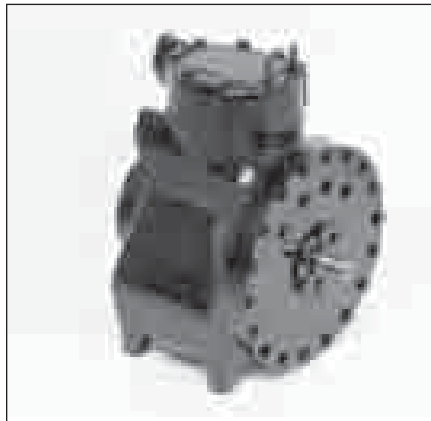

Compressor, Reman. (05K 12 CFM) 7XX/6XX
 Order Part #: P-18-60000-04RM
 (Replaces Carrier #: 18-60000-04)

Thermo King POE compressor oil will not work in Carrier compressor applications. Refer to compressor-oil reference chart

COMPRESSOR

Compressor Oil Reference Chart

Oil Type	Viscosity	Refrigerant						Type of equipment					Typical use*
		R-12	R-22	R-500	R-502	R-134a	R-404a	Trailer	Truck	Bus	Contr.	TK Part #	
Mineral	150	X	X	X				X	X		X	67-426	Carrier 05G/05K
Synthetic	100	X	X	X	X			X				67-404	Carrier 05G
POE	68					X	X	X	X	X		P-07-00317-00	Carrier 05G/05K

* Always refer to your unit service manual for proper oil type

COMPRESSOR CLEANUP SUPPLIES

COMPRESSOR



Acid Kit, (POE Oil) Pkg/2
Order Part #: P-07-00337-00
(Replaces Carrier #: 07-00337-00)



Kit, Acid Test
Order Part #: 203-346
(Replaces Carrier #: 07-00260-00)



Adapter, 05K Compressor Filter
Order Part #: P-14-60043-00
(Replaces Carrier #: 14-60043-00)

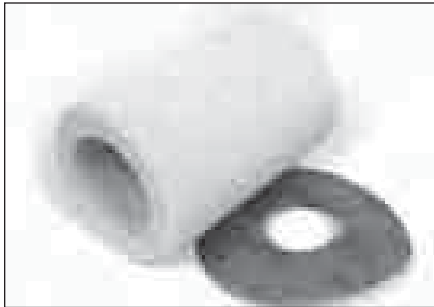

Filter Element, Suction Acid
Order Part #: P-14-50054-00
(Replaces Carrier #: 14-50054-00)



Filter Element, Suction Pleated
Order Part #: P-14-50055-00
(Replaces Carrier #: 14-50055-00)



Filter, Sock
Order Part #: P-58-04165-00
(Replaces Carrier #: 58-04165-00)
Filter, Sock
Order Part #: P-58-00869-00
(Replaces Carrier #: 58-00869-00)



Suction Filter Kit, Compressor
Order Part #: P-07-00379-00
(Replaces Carrier #: 07-00379-00)

Stainless Steel Tubes for Longer Life than Carrier's



Oil Filter Kit, Compressor
Order Part #: P-07-00380-00-B
(Replaces Carrier #: 07-00380-00)

Filter, Oil Compressor
(Replacement filter for PG kit only)
Order Part #: 66-7800

COMPRESSOR COMPONENTS



**Bearing, Shaft End
(Unmachined)**

Order Part #: P-17-44015-00
(Replaces Carrier #: 17-44015-00)

(Machined)

Order Part #: P-17-44015-MA



Cap, Service Valve

Order Part #: P-17-10812-00
(Replaces Carrier #: 17-10812-00)



**Crankshaft (05G 37 CFM)
(Vane Pump Only)**

Order Part #: P-17-44010-00
(Replaces Carrier #: 17-44010-00)



**Crankshaft (05G 37 CFM)
(All Gear Pumps)**

Order Part #: P-17-40410-00
(Replaces Carrier #: 17-40410-00)



**Crankshaft (05G 41 CFM)
(All Gear Pumps)**

Order Part #: P-17-40412-00
(Replaces Carrier #: 17-40412-00)

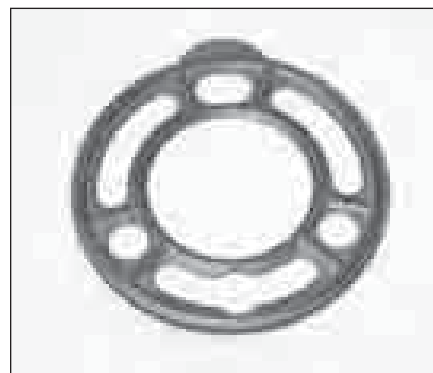

Gasket, Unloader

Order Part #: P-17-40104-07
(Replaces Carrier #: 17-40104-07)

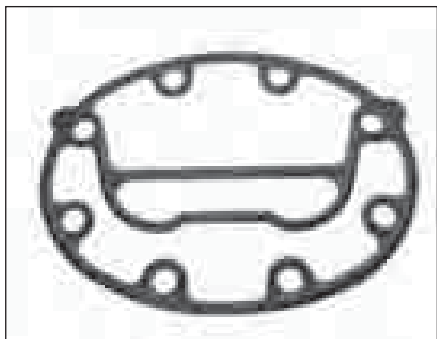

**Gasket, Suction Cutoff
Unloader Head**

Order Part #: P-17-44125-00
(Replaces Carrier #: 17-44125-00)

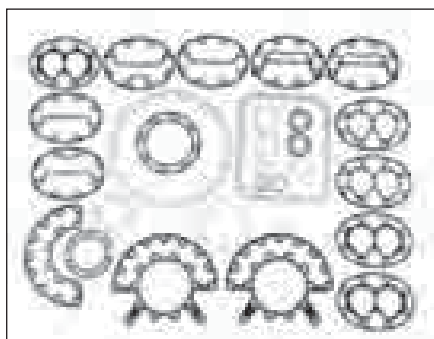

**Gasket Set, Compressor
(05G) (Fiber)**

Order Part #: P-17-55020-20
(Replaces Carrier #: 17-55020-20)



Gasket, Bottom Plate

Order Part #: P-17-40033-05
(Replaces Carrier #: 17-40033-05)

Truck & Trailer Parts – COMPRESSOR

COMPRESSOR

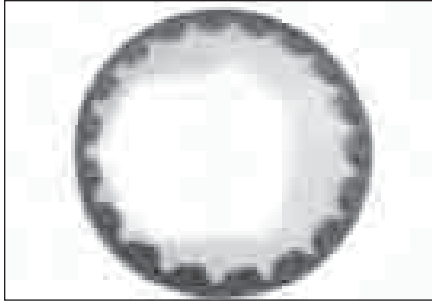

Gasket, Cover (05D, 06D)

Order Part #: P-17-40029-05
(Replaces Carrier #: 17-40029-05)



Gasket, Cover

Order Part #: P-17-40075-05
(Replaces Carrier #: 17-40075-05)

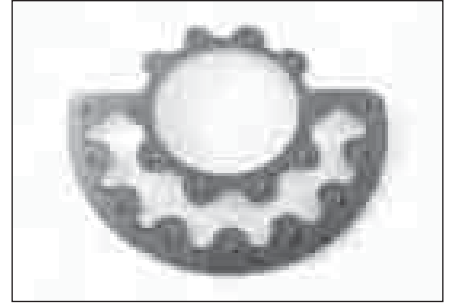

Gasket, End Plate (Fiber)

Order Part #: P-17-44119-00
(Replaces Carrier #: 17-44119-00)

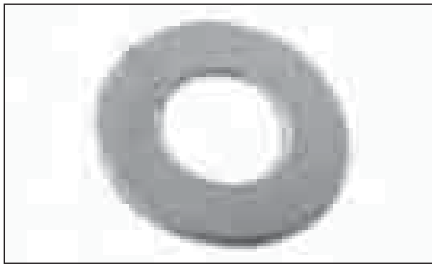

Gasket, Flange

Order Part #: P-17-44014-00
(Replaces Carrier #: 17-44014-00)

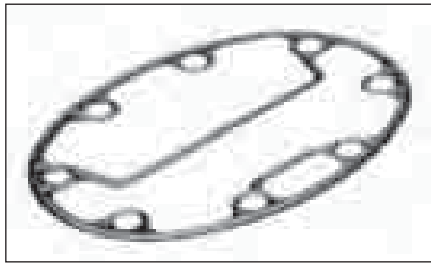

Gasket, Head Center

Order Part #: P-17-44123-00
(Replaces Carrier #: 17-44123-00)

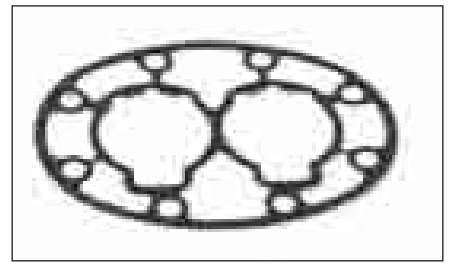

Gasket, Head (Metal) (05K)

Order Part #: P-17-55002-00
(Replaces Carrier #: 17-55002-00)

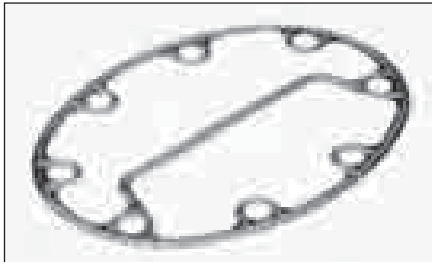

Gasket, Head w/o Unloaders

Order Part #: P-17-44124-00
(Replaces Carrier #: 17-44124-00)

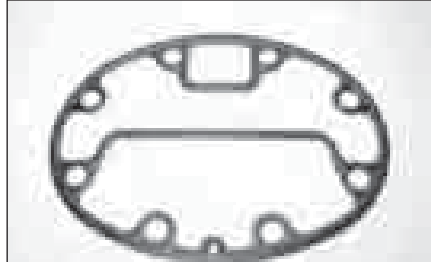

Gasket, Head

Order Part #: P-17-44126-00
(Replaces Carrier #: 17-44126-00)

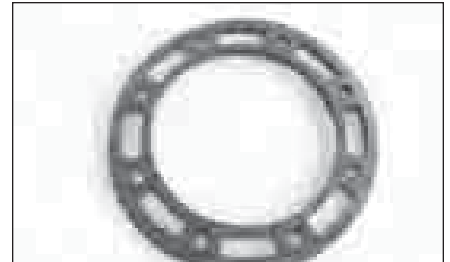

Gasket, Pump End

Order Part #: P-17-40078-05
(Replaces Carrier #: 17-40078-05)

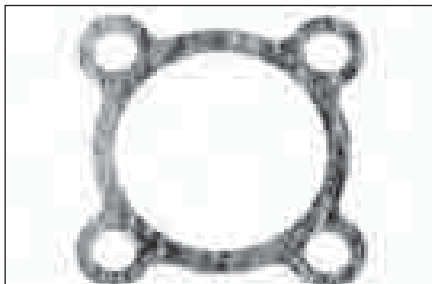

Gasket, Service Valve (Suction)

Order Part #: P-17-40005-05
(Replaces Carrier #: 17-40005-05)



Gasket, Service Valve (Discharge) (Metal)

Order Part #: P-17-44138-00
(Replaces Carrier #: 17-44138-00)

(Fiber)

Order Part #: P-17-10811-05
(Replaces Carrier #: 17-10811-05)



Gasket, Service Valve (05K) (Discharge)

Order Part #: P-17-21003-00
(Replaces Carrier #: 17-21003-00)

Truck & Trailer Parts – COMPRESSOR

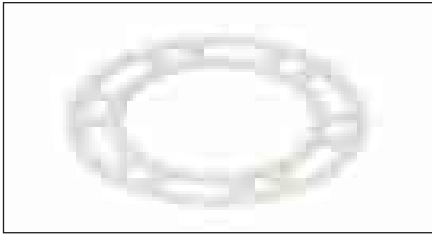

Gasket, Shaft Seal (Fiber)

Order Part #: P-17-44004-06
(Replaces Carrier #: 17-44004-06)

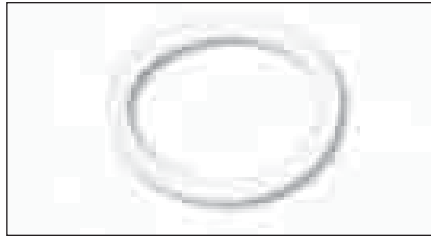

Gasket, Sight Glass

Order Part #: P-17-10218-02
(Replaces Carrier #: 17-10218-02)

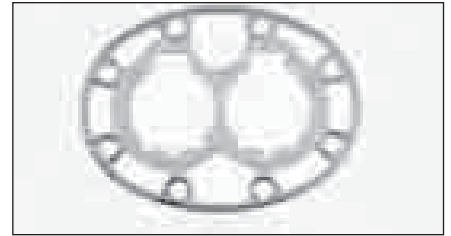

Gasket, Valve Plate (05G) (Metal)

Order Part #: P-17-44007-06
(Replaces Carrier #: 17-44007-06)

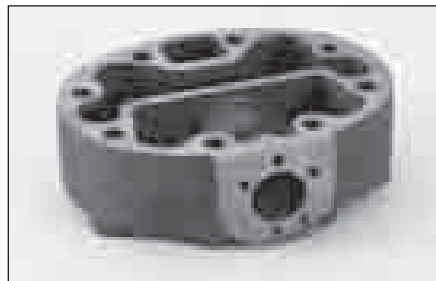

Head, Cylinder (05G) HGBP Unloader

Order Part #: P-17-40104-05
(Replaces Carrier #: 17-40104-05)



Flange, Ultra

Order Part #: P-17-44025-00
(Replaces Carrier #: 17-44025-00)

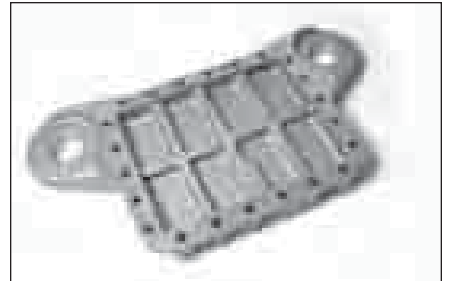

Sump, Ultra

Order Part #: P-17-44026-00
(Replaces Carrier #: 17-44026-00)

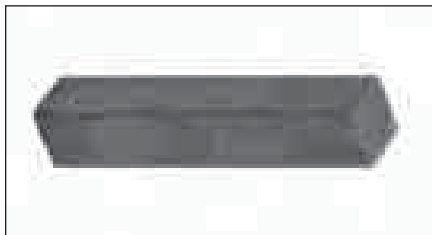

Key, Crankshaft (05G)

Order Part #: P-17-40324-00
(Replaces Carrier #: 17-40324-00)

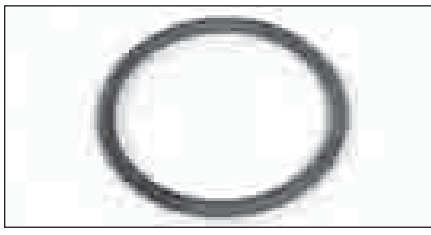

O-Ring

Order Part #: 33-230
(Replaces Carrier #: 17-44043-02)

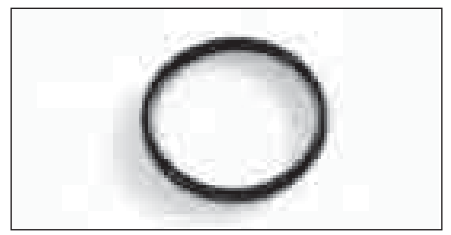

O-Ring

Order Part #: P-17-55022-00
(Replaces Carrier #: 17-55022-00)

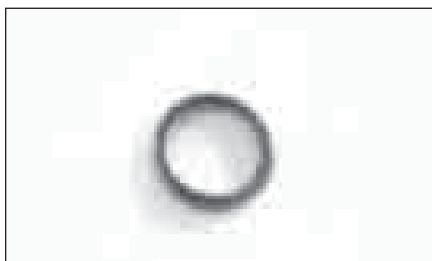

O-Ring, Oil Tube

Order Part #: P-42-00243-09
(Replaces Carrier #: 42-00243-09)



Oil, Comp (Alkylbenzene)

Order Part #: 67-404 (Case)
(Replaces Carrier #: 07-00274-00)

Truck & Trailer Parts – COMPRESSOR

COMPRESSOR



Oil, Comp (Polyolester)

Order Part #: P-07-00317-00
(Replaces Carrier #: 07-00317-00)



Pin Dowel

Order Part #: P-17-40057-00
(Replaces Carrier #: 17-40057-00)

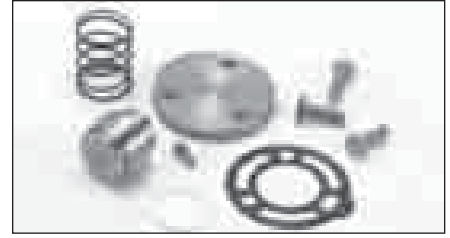

Plug Kit Unloader

Order Part #: P-17-55013-00
(Replaces Carrier #: 17-55013-00)



Piston, Flat 37 CFM (Std)

Order Part #: P-17-44045-01
(Replaces Carrier #: 17-44045-01)

Piston, Flat 37 CFM (+.020")

Order Part #: P-17-44045-03
(Replaces Carrier #: 17-44045-03)



Piston, 37 CFM Contour Head (Std)

Order Part #: P-17-44016-05
(Replaces Carrier #: 17-44016-05)

Piston, 37 CFM Contour Head (+.020")

Order Part #: P-17-44016-07
(Replaces Carrier #: 17-44016-07)



Piston, 2 Ring, 41 CFM Cont Head (Std)

Order Part #: P-17-44115-01
(Replaces Carrier #: 17-44115-01)

Piston, 2 Ring, 41 CFM Cont Head (+.020")

Order Part #: P-17-44115-20
(Replaces Carrier #: 17-44115-20)



Piston, Flat 37 CFM (Std)

Order Part #: P-17-44045-01
(Replaces Carrier #: 17-44045-01)

Piston, Flat 37 CFM (+.020")

Order Part #: P-17-44045-03
(Replaces Carrier #: 17-44045-03)



Piston, 37 CFM Contour Head (Std)

Order Part #: P-17-44016-05
(Replaces Carrier #: 17-44016-05)

Piston, 37 CFM Contour Head (+.020")

Order Part #: P-17-44016-07
(Replaces Carrier #: 17-44016-07)



Piston, 2 Ring, 41 CFM Cont Head (Std)

Order Part #: P-17-44115-01
(Replaces Carrier #: 17-44115-01)

Piston, 2 Ring, 41 CFM Cont Head (+.020")

Order Part #: P-17-44115-20
(Replaces Carrier #: 17-44115-20)



Pump, Oil (Universal Gear)

Order Part #: P-17-44137-00
(Replaces Carrier #: 17-44137-00)

Pump, Oil (Vane)

Order Part #: P-17-40200-02
(Replaces Carrier #: 17-40200-02)

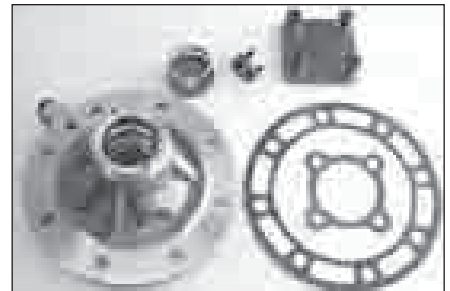

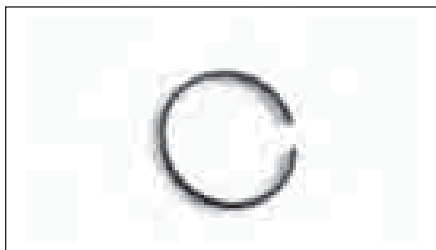

Ring, Oil (only for older 37 cfm pistons with wider lower groove)
Order Part #: P-17-40054-00
(Replaces Carrier #: 17-40054-00)

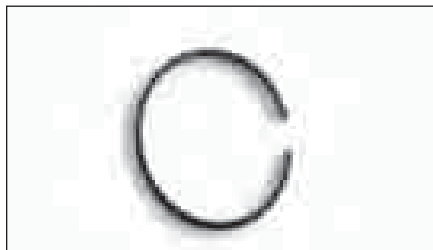

Ring, Piston (05G) (Std.)
Order Part #: P-17-40055-00
(Replaces Carrier #: 17-40055-00)



Rod, Connecting (Std)
Order Part #: P-17-40056-02
(Replaces Carrier #: 17-40056-02)

Ring, Piston (05G) (+.020")
Order Part #: P-17-55025-00
(Replaces Carrier #: 17-55025-00)

Rod, Connecting (+.010")
Order Part #: P-17-55023-00
(Replaces Carrier #: 17-55023-00)

Rod, Connecting (+.020")
Order Part #: P-17-ROD020-05G

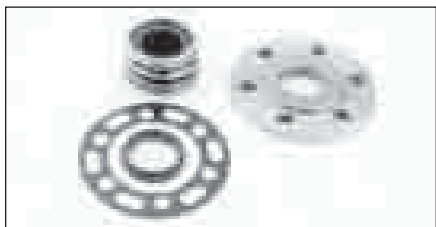

Seal, Compressor (05K)
Order Part #: P-17-44740-00
(Replaces Carrier #: 17-44740-00)

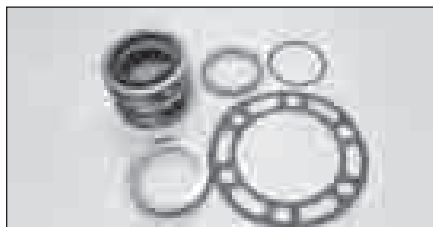

Seal, Shaft (05G w/Elec Stby)
Order Part #: P-17-44150-00
(Replaces Carrier #: 17-44150-00)

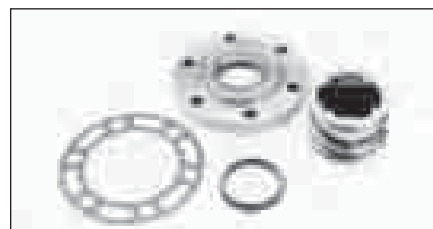

Seal, Shaft (05D)
Order Part #: P-17-44135-00
(Replaces Carrier #: 17-44135-00)

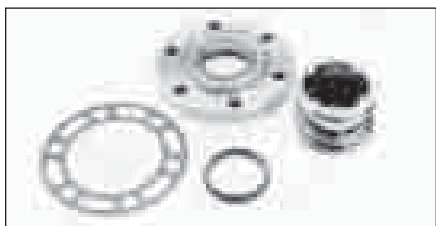

Seal, Shaft (05G)
Order Part #: P-17-44145-00
(Replaces Carrier #: 17-44145-00)



Sightglass
Order Part #: P-17-10218-00
(Replaces Carrier #: 17-10218-00)

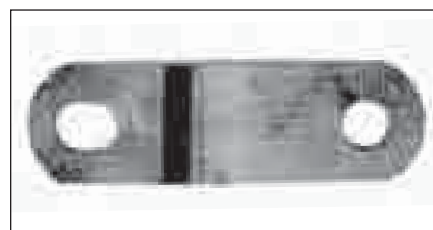

Spring, Suction Valve
Order Part #: P-17-40083-00
(Replaces Carrier #: 17-40083-00)



Screen, Oil Filter (05G)
Order Part #: P-17-40020-00
(Replaces Carrier #: 17-40020-00)

Truck & Trailer Parts – COMPRESSOR

COMPRESSOR

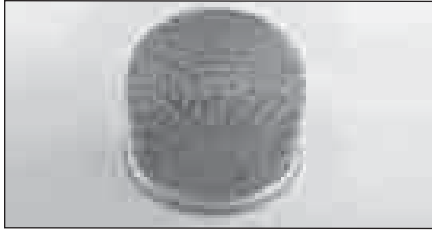

Strainer, Suction (05G)
 Order Part #: P-17-44005-00
 (Replaces Carrier #: 17-44005-00)

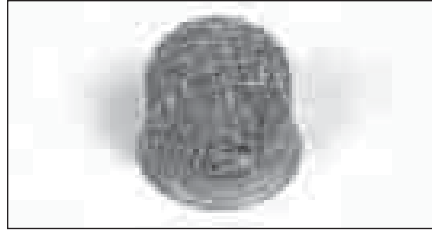

Strainer, Suction (05G)
 Order Part #: P-17-44716-00
 (Replaces Carrier #: 17-44716-00)

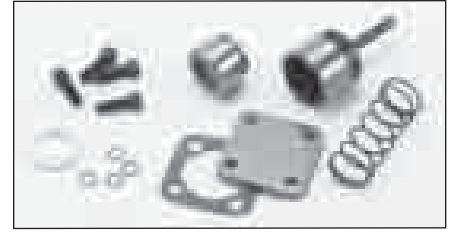

Suction Cutoff Unloader Repair Kit
 Order Part #: P-17-21055-00
 (Replaces Carrier #: 17-21055-00)

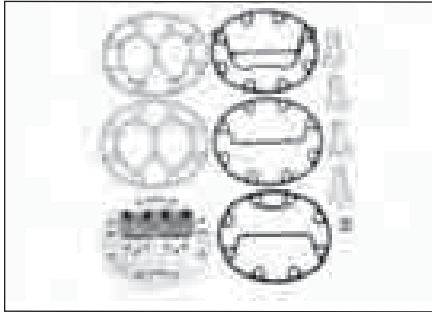

Valve Plate (Canted, Center or Side Bank)
 Order Part #: P-17-44105-00
 (Replaces Carrier #: 17-44105-00)

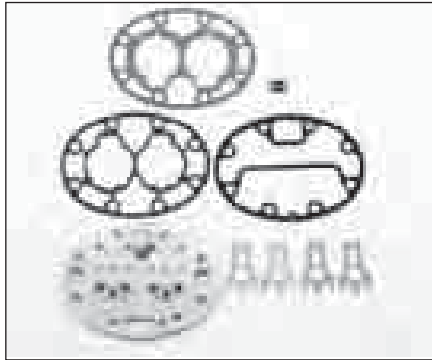

Valve Plate (Canted, Side Bank w/HGBP)
 Order Part #: P-17-44104-00
 (Replaces Carrier #: 17-44104-00)

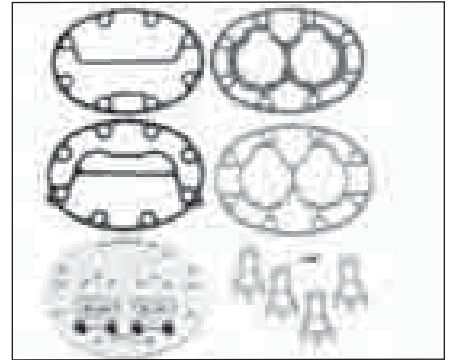

Valve Plate (Flat, Ctr or Side w/Suc.Cutoff)
 Order Part #: P-17-44107-00
 (Replaces Carrier #: 17-44107-00)

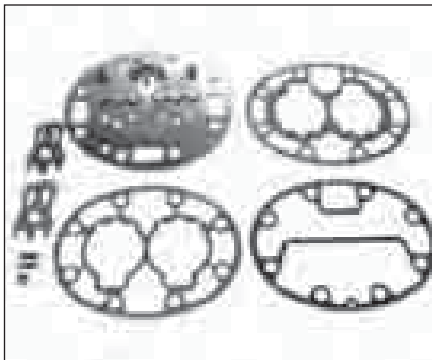

Valve Plate (Flat, Side Bank w/HGBP)
 Order Part #: P-17-44106-00
 (Replaces Carrier #: 17-44106-00)

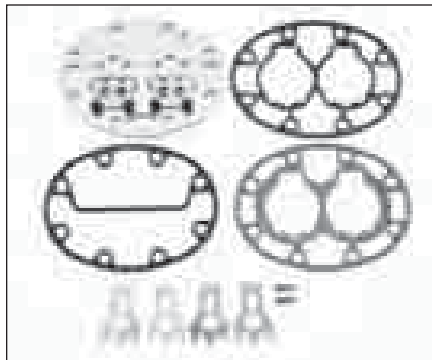

Valve Plate (Flat, Side Bank w/no unload)
 Order Part #: P-17-44099-00
 (Replaces Carrier #: 17-44099-00)

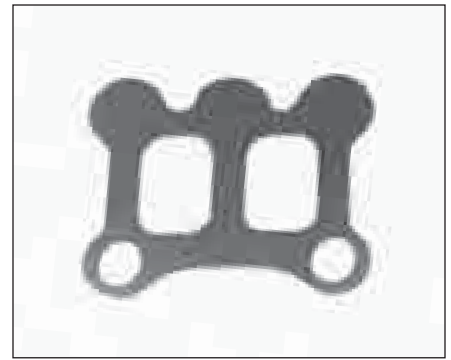

Valve, Discharge
 Order Part #: P-17-40086-00
 (Replaces Carrier #: 17-40086-00)

Truck & Trailer Parts – COMPRESSOR



Valve, Suction (05G)

Order Part #: P-17-44111-00
(Replaces Carrier #: 17-44111-00)

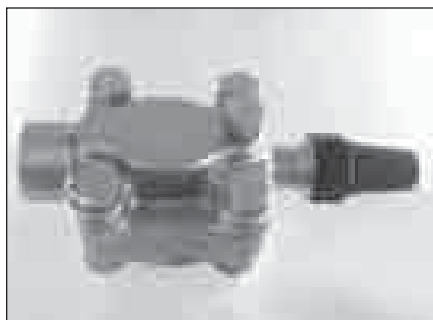

Valve, Service Suction

Order Part #: P-17-40002-01
(Replaces Carrier #: 17-40002-01)



Valve, Service 7/8"

Order Part #: P-14-01042-04
(Replaces Carrier #: 14-01042-04)

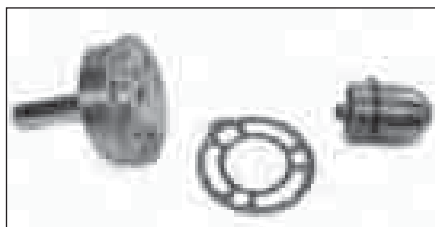

Valve, Unloader

Order Part #: P-17-40417-00
(Replaces Carrier #: 17-40417-00)

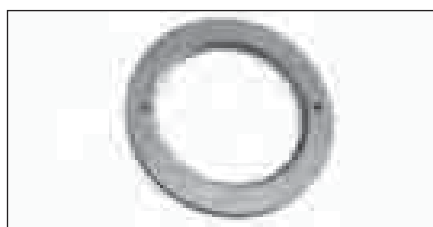

Washer, Thrust (Pump End)

Order Part #: P-17-55009-01
(Replaces Carrier #: 17-55009-01)

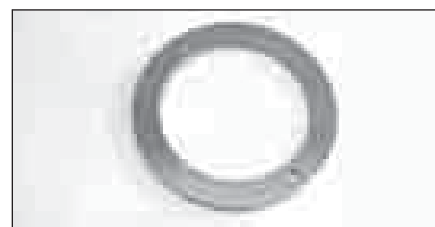

Washer, Thrust (Seal End)

Order Part #: P-17-44008-00
(Replaces Carrier #: 17-44008-00)

COMPRESSOR

EON Power Pack

Auxiliary lighting power supply.



Economical auxiliary power for operating lights

- Avoid dead truck batteries
- Powered by a long-lasting EON battery
- Easy to install
- Weatherproof enclosure

KIT INCLUDES:

- Low voltage disconnect to maximize battery life
- Charging circuit to connect system to reefer or truck alternator

Available Option:

- Weatherproof switch with integrated 45-minute timer



Espar Airtronic® D2/D4 Air Heaters

For comfortable truck cab and sleeper heat
without engine idling

Choose Espar Cab and Sleeper Heat from Thermo King

- Reduce fuel, engine idling and maintenance costs
- Automatic heat regulation through four heat levels
- Low fuel and electrical power consumption
- Self-diagnostics

Espar Kit Options

(each kit includes heater)

AIRTRONIC 2 TRUCK KITS

(all kits below include harness, fuel system, ducting, mounting bracket, control option/timer, fuel pickup pipe, hardware kit, exhaust and intake pipes unless otherwise noted)

12 volt with mini-controller.....	840837
12 volt with thermostat	840838
12 volt with mini-controller and 90° outlet hood.....	840839
12 volt with 7-day timer.....	840842
12 volt with mini-controller (no fuel pickup pipe).....	800110
12 volt with thermostat (no fuel pickup pipe).....	800111
24 volt with thermostat	840841

AIRTRONIC 4 TRUCK KITS

(all kits below include harness, fuel system, ducting, mounting bracket, control option/timer, fuel pickup pipe, hardware kit, exhaust and intake pipes)

12 volt with mini-controller	840846
12 volt with thermostat	840847

AIRTRONIC 2

12 volt basic heater only.....	840843
24 volt basic heater only.....	840844

AIRTRONIC 4

12 volt basic heater only.....	840849
24 volt basic heater only.....	840850

Gasoline versions also available.



Airtronic D2

Heat Output

BTU/hr(KW)
7500 (2.2) Boost
6150 (1.8) High
4100 (1.2) Medium
2900 (0.8) Low

Fuel Consumption

gal/hr (L/hr)
0.07 (0.27) Boost
0.06 (0.21) High
0.04 (0.14) Medium
0.02 (0.10) Low

Electrical Consumption

2.8 amps Boost
1.9 amps High
1.0 amps Medium
0.67 amps Low
Air Throughput
48 cfm Boost
40 cfm High
27 cfm Medium
19 cfm Low

Weight

6 lbs. (2.7 kg)

Dimensions

L= 12.2" (31 cm)
W= 4.5" (11.5 cm)
H= 4.8" (12.2 cm)

Airtronic D4

Heat Output

BTU/hr(KW)
13,600 (4.0) Boost
10,200 (3.0) High
6,800 (2.0) Medium
3,400 (1.0) Low

Fuel Consumption

gal/hr (L/hr)
0.13 (0.51) Boost
0.10 (0.38) High
0.07 (0.25) Medium
0.03 (0.13) Low

Electrical Consumption

3.3 amps Boost
2.0 amps High
1.1 amps Medium
0.6 amps Low

Air Throughput

85 cfm Boost
69 cfm High
50 cfm Medium
30 cfm Low

Weight

9.9 lbs. (4.5 kg)

Dimensions

L= 14.6" (37 cm)
W= 5.5" (14 cm)
H= 5.9" (15 cm)

Specifications provided by Espar Heating Systems

Truck & Trailer Parts – REFRIGERATION

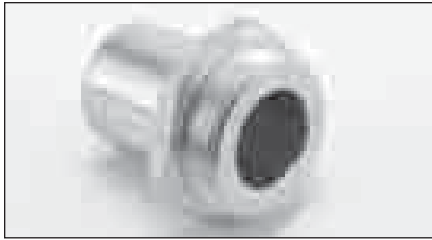

Cap, Check Valve

Order Part #: P-14-50051-00
(Replaces Carrier #: 14-50051-00)

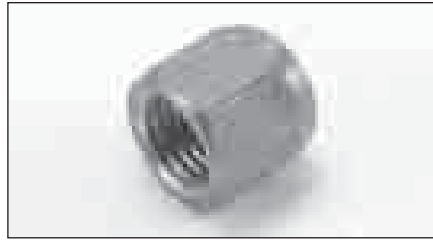

Cap, Flare

Order Part #: P-40-00086-04
(Replaces Carrier #: 40-00086-04)

Looking for vehicle-
powered clutch and
compressor parts?

Check with your local
Thermo King Dealer.



Coil, Condenser (30S)

Order Part #: P-08-60059-01
(Replaces Carrier #: 08-60059-01)

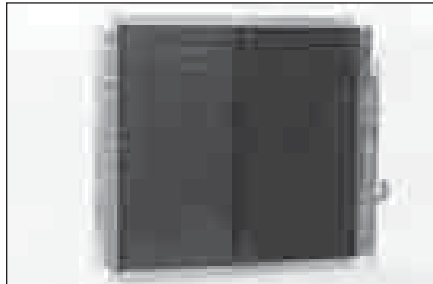

Coil, Condenser

Order Part #: P-08-00206-11SV
(Replaces Carrier #: 08-00206-11SV)

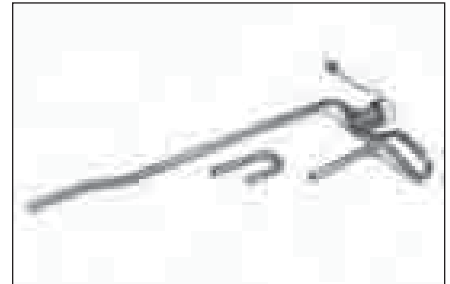

Tubing Kit, Ultra Coil

Order Part #: P-79-02327-16
(Replaces Carrier #: 79-02327-16)

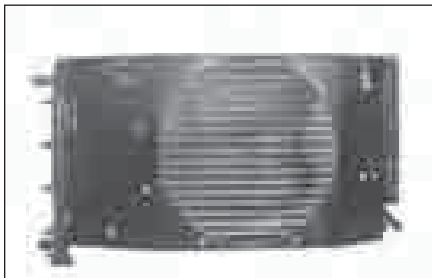

Coil, Condenser/Radiator (6XX/7XX)

Order Part #: P-08-60086-04-SP
(Replaces Carrier #: 08-60086-04-SP)

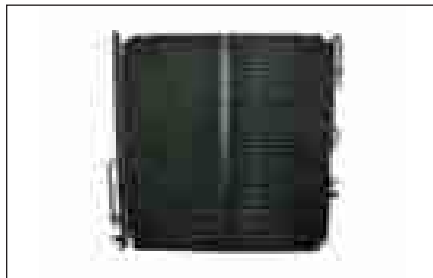

Coil, Condenser/Radiator (Ultima)

Order Part #: P-08-01058-03SV
(Replaces Carrier #: 08-01058-03SV)



Coil, Radiator

Order Part #: P-08-00181-03
(Replaces Carrier #: 08-00181-03)



Collar, Female, ORS, 1/4" (4)

Order Part #: P-40-60008-01
(Replaces Carrier #: 40-60008-01)



Collar, Female, ORS, 3/8" (6)

Order Part #: P-40-60008-02
(Replaces Carrier #: 40-60008-02)

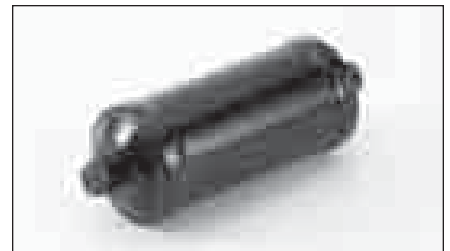

Drier

Order Part #: P-14-00326-00
(Replaces Carrier #: 14-00326-00)

Truck & Trailer Parts – REFRIGERATION

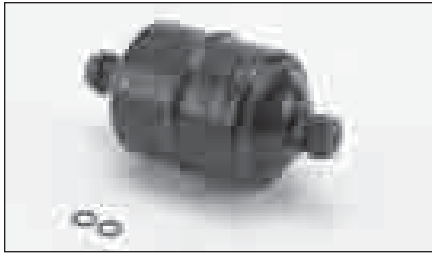

Drier

Order Part #: P-14-00326-04
(Replaces Carrier #: 14-00326-04)



Drier, Filter

Order Part #: P-14-00326-05
(Replaces Carrier #: 14-00326-05)

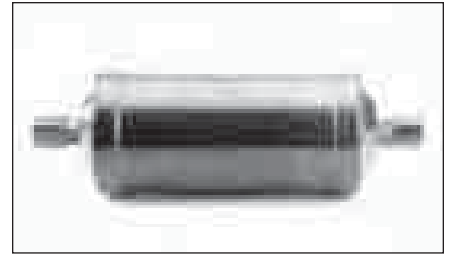

Drier, Filter (High Acid Capacity)

Order Part #: P-14-00036-00
(Replaces Carrier #: 14-00036-00)

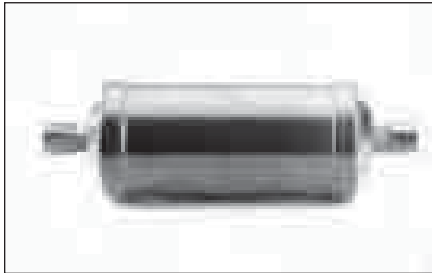

Drier, Filter

Order Part #: 66-1723
(Replaces Carrier #: 14-00036-02)



Drier, Filter with O-Rings (High Moisture Capacity)

Order Part #: P-14-00209-00
(Replaces Carrier #: 14-00209-00)

**Need an Additional
O-Ring
for this
drier?**



O-Ring, Drier

Order Part #: P-14-00209-20
(Replaces Carrier #: 14-00209-20)

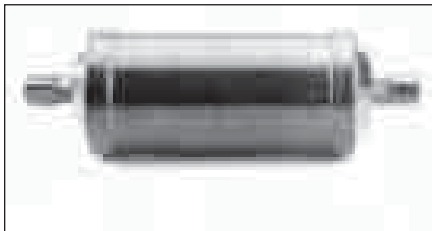

Drier, Filter (R22)

Order Part #: P-14-50041-00
(Replaces Carrier #: 14-50041-00)

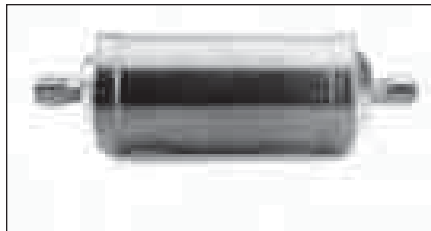

Drier, Filter

Order Part #: P-14-01063-05
(Replaces Carrier #: 14-01063-05)

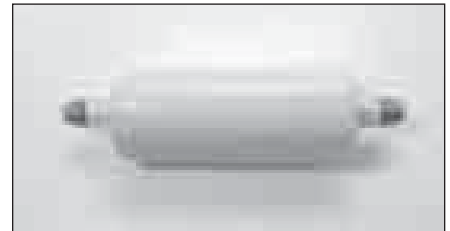

Drier, Filter

Order Part #: P-14-60066-00
(Replaces Carrier #: 14-60066-00)

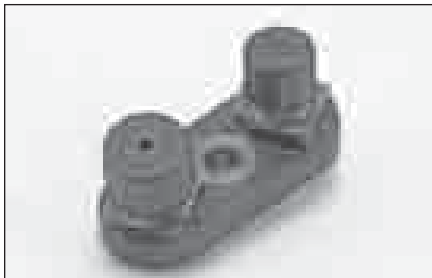

Flange, Compressor

Order Part #: P-40-50031-00
(Replaces Carrier #: 40-50031-00)



Gasket Set, 3 Way Valve

Order Part #: P-14-50046-00
(Replaces Carrier #: 14-50046-00)



Indicator, Moisture

Order Part #: P-14-01092-03
(Replaces Carrier #: 14-01092-03)

Truck & Trailer Parts – REFRIGERATION



Indicator, Moisture

Order Part #: P-14-01092-05
(Replaces Carrier #: 14-01092-05)



Sightglass

Order Part #: P-14-01092-12
(Replaces Carrier #: 14-01092-12)

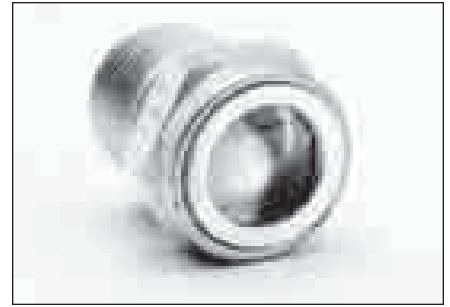

Indicator, Sightglass

Order Part #: P-14-00220-00
(Replaces Carrier #: 14-00220-00)



O-RINGS SOLD INDIVIDUALLY



O-Ring - 3/8"

Order Part #: P-42-60052-01
(Replaces Carrier #: 42-60052-01)

O-Ring .489 ID X .070 THK

Order Part #: P-42-00243-04
(Replaces Carrier #: 42-00243-04)

O-Ring .926 ID X .070

Order Part #: P-42-00243-16
(Replaces Carrier #: 42-00243-16)

O-Ring .301 ID X .070 THK

Order Part #: P-42-00243-10
(Replaces Carrier #: 42-00243-10)

O-Ring .551 ID X .070 THK

Order Part #: P-42-00243-13
(Replaces Carrier #: 42-00243-13)

O-Ring, Drier

Order Part #: P-14-00209-20
(Replaces Carrier #: 14-00209-20)

O-Ring .426 ID X .070 THK

Order Part #: P-42-00243-12
(Replaces Carrier #: 42-00243-12)

O-Ring .614 ID X .070 THK

Order Part #: P-42-00243-03
(Replaces Carrier #: 42-00243-03)

O-Ring, Service Valve

Order Part #: P-42-01159-00
(Replaces Carrier #: 42-01159-00)

REFRIGERATION



Sightglass (Prism Style)

Order Part #: P-14-50023-00
(Replaces Carrier #: 14-50023-00)



Plug, Fusible, Safety (1/4" MPT)

Order Part #: P-14-01032-00
(Replaces Carrier #: 14-01032-00)



Solenoid Valve Kit

Order Part #: P-16-00513-02
(Replaces Carrier #: 16-00513-02)

Truck & Trailer Parts – REFRIGERATION



Kit, Repair (SV-1)
 (Specific to Carrier OEM solenoid valve. Do not use in P-14-01114-01 application.)
 Order Part #: P-14-01114-50
 (Replaces Carrier #: 14-01114-50)

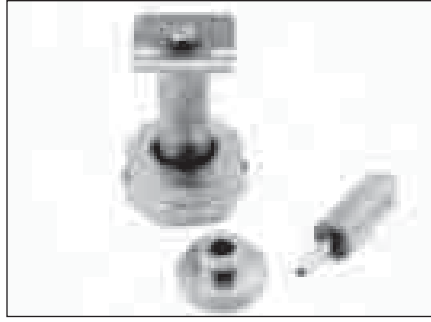

Solenoid Valve Kit (SV-3)
 (Specific to Carrier OEM solenoid valve. Do not use in P-14-01113-01 application.)
 Order Part #: P-14-01113-50-C
 (Replaces Carrier #: 14-01113-50)



Solenoid Valve Kit (SV-2 & SV-4)
 Order Part #: P-14-00150-51
 (Replaces Carrier #: 14-00150-50 and 14-00150-51)



Valve, Solenoid w/o Coil (SV-2 & SV-4)
 Order Part #: P-14-00150-14
 (Replaces Carrier #: 14-00150-14)

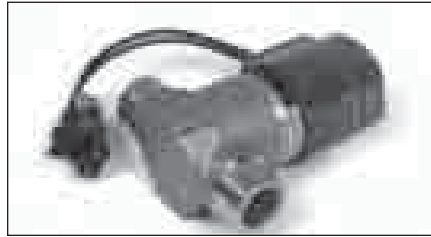

Valve, Solenoid w/coil (SV-1)
 Order Part #: P-14-01114-01
 (Replaces Carrier #: 14-01114-01)



Valve, Solenoid (SV-3)
 Order Part #: P-14-01113-01
 (Replaces Carrier #: 14-01113-01)

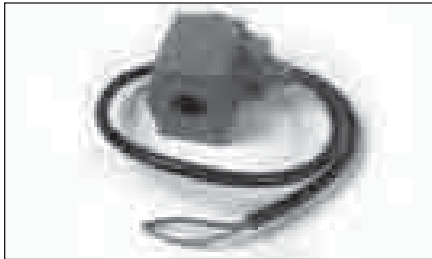

Coil, Solenoid 12V
 Order Part #: P-22-60268-00
 (Replaces Carrier #: 22-60268-00)

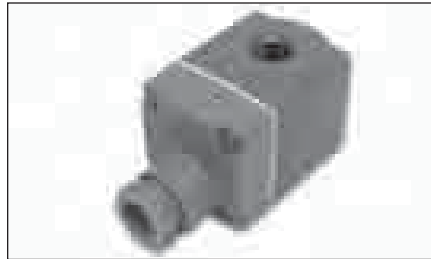

Coil, Solenoid 12V
 Order Part #: P-22-60307-00
 (Replaces Carrier #: 22-60307-00)

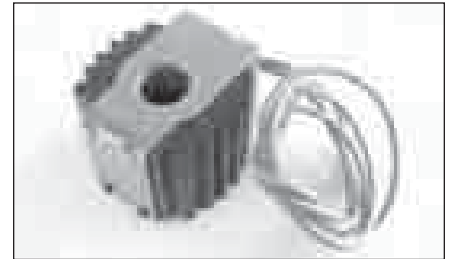

Coil, Solenoid (24VDC)
 Order Part #: P-14-01091-02
 (Replaces Carrier #: 14-01091-02)

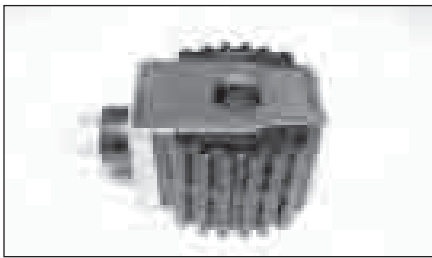

Coil, Solenoid (SV-1)
 Order Part #: P-14-00147-05
 (Replaces Carrier #: 14-00147-05)

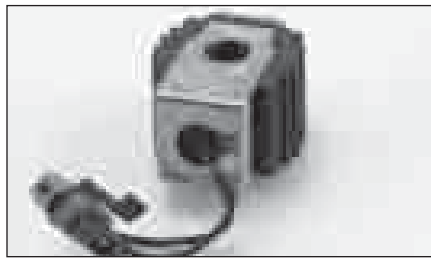

Coil, Solenoid (SV-1)
 Order Part #: P-14-01114-20
 (Replaces Carrier #: 14-01114-20)

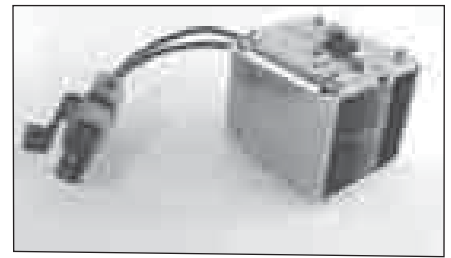

Coil, Solenoid (SV-2 & 4)
 Order Part #: P-22-02579-00
 (Replaces Carrier #: 22-02579-00)

Truck & Trailer Parts – REFRIGERATION

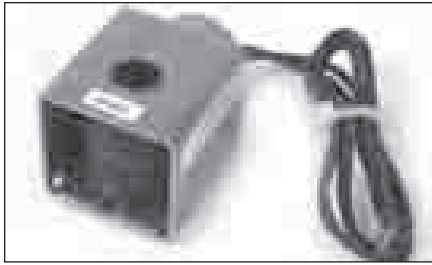

Coil, Solenoid (SV-2/SV-4)
Order Part #: P-22-02567-00
(Replaces Carrier #: 22-02567-00)

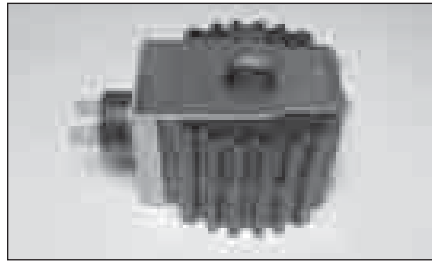

Coil, Solenoid (SV-3)
Order Part #: P-14-00145-03
(Replaces Carrier #: 14-00145-03)

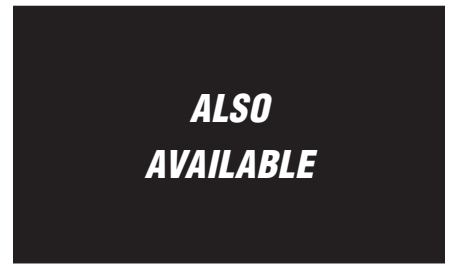

Coil, 3-Way Valve (12V)
Order Part #: P-14-01110-01
(Replaces Carrier #: 14-01110-01)

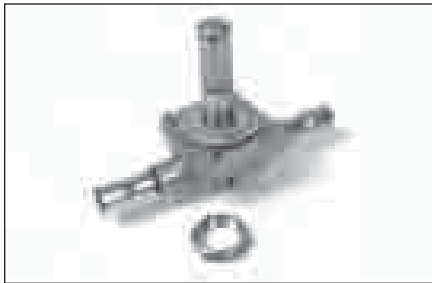

Valve
Order Part #: P-14-60063-00
(Replaces Carrier #: 14-60063-00)



Valve, TXV R12
Order Part #: P-14-00177-00
(Replaces Carrier #: 14-00177-00)



**Valve (TXV)
Less Flange R22**
Order Part #: P-14-01104-04
(Replaces Carrier #: 14-01104-04)



**Valve (TXV)
Less Flange R22**
Order Part #: P-14-01104-23
(Replaces Carrier #: 14-01104-23)



Valve (TXV) Less Flange
Order Part #: P-14-00177-03
(Replaces Carrier #: 14-00177-03)



**Valve (TXV)
Less Flange R500**
Order Part #: P-14-00177-01
(Replaces Carrier #: 14-00177-01)



**Valve (TXV)
Less Flange R502**
Order Part #: P-14-01095-04
(Replaces Carrier #: 14-01095-04)



Valve (TXV), Quench R22
Order Part #: P-14-00190-06
(Replaces Carrier #: 14-00190-06)



Valve (TXV), Quench R22
Order Part #: P-14-00190-00
(Replaces Carrier #: 14-00190-00)

Truck & Trailer Parts – REFRIGERATION



Valve (TXV), Quench R22

Order Part #: P-14-00190-03
(Replaces Carrier #: 14-00190-03)



Orifice, TXV

Order Part #: P-14-60009-04
(Replaces Carrier #: 14-60009-04)



Valve, Expansion R22

Order Part #: P-14-60022-00
(Replaces Carrier #: 14-60022-00)



Valve (TXV), Quench R22

Order Part #: P-14-00190-05
(Replaces Carrier #: 14-00190-05)

Orifice, TXV (NO. 2)

Order Part #: 61-1261
(Replaces Carrier #: 14-60009-02)

Orifice, TXV (NO. 3)

Order Part #: P-14-60009-03
(Replaces Carrier #: 14-60009-03)

Orifice, TXV (NO. 5)

Order Part #: P-14-60009-05
(Replaces Carrier #: 14-60009-05)

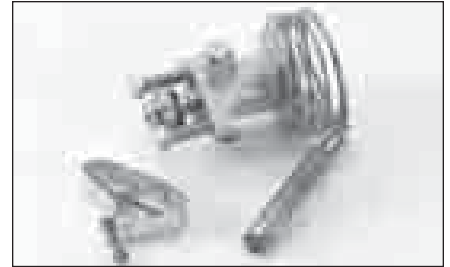

Valve, Expansion R404A

Order Part #: P-14-01104-36
(Replaces Carrier #: 14-01104-36)

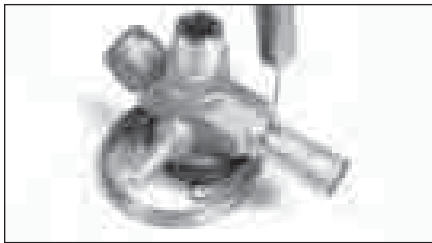

Valve, Expansion R404A

Order Part #: P-14-60039-00
(Replaces Carrier #: 14-60039-00)

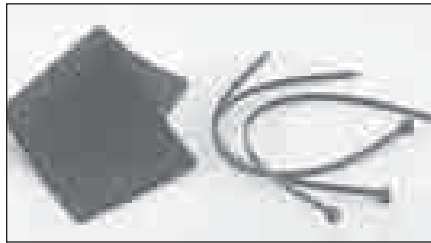

Insulator Kit, (Quench Valve)

Order Part #: P-76-50056-00
(Replaces Carrier #: 76-50056-00)

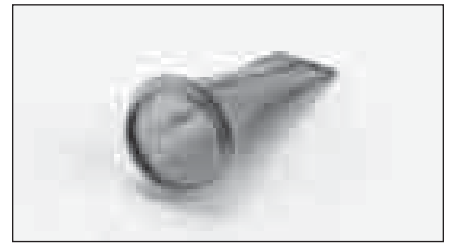

Strainer

Order Part #: P-14-00176-00
(Replaces Carrier #: 14-00176-00)



Seat, Check Valve

Order Part #: P-16-00171-00
(Replaces Carrier #: 16-00171-00)

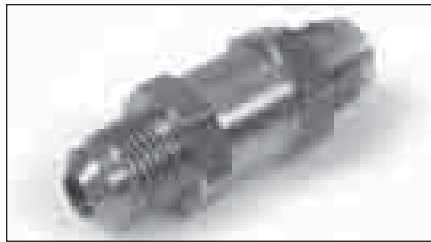

Valve Check

Order Part #: P-14-00181-02
(Replaces Carrier #: 14-00181-02)

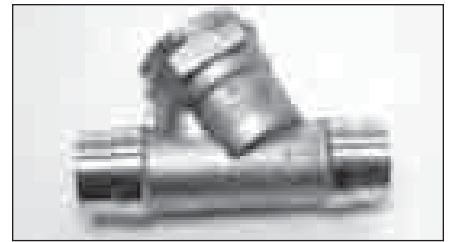

Valve, Check

Order Part #: P-14-00029-07
(Replaces Carrier #: 14-00029-07)

Truck & Trailer Parts – REFRIGERATION

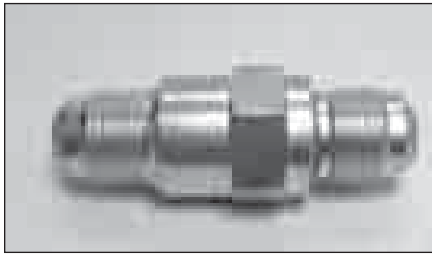

Valve, Check

Order Part #: P-14-00181-03
(Replaces Carrier #: 14-00181-03)



Valve, Check 1/4 (R22)

Order Part #: P-14-00181-00
(Replaces Carrier #: 14-00181-00)

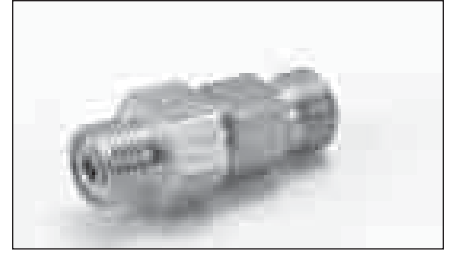

Valve, Check 1/4 ORS

Order Part #: P-14-60026-00
(Replaces Carrier #: 14-60026-00)



Valve, Check 3/8"

Order Part #: P-14-00286-00
(Replaces Carrier #: 14-00286-00)



Valve, Check 3/8 ORS

Order Part #: P-14-60026-01
(Replaces Carrier #: 14-60026-01)

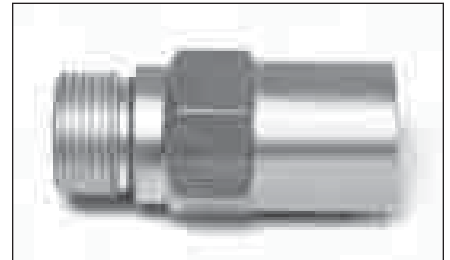

Valve, Check 5/8"

Order Part #: P-14-00286-03
(Replaces Carrier #: 14-00286-03)



Valve, Check Repair Kit

Order Part #: P-14-50050-01
(Replaces Carrier #: 14-50050-01)



Valve, Check

Order Part #: P-14-00281-02
(Replaces Carrier #: 14-00281-02)

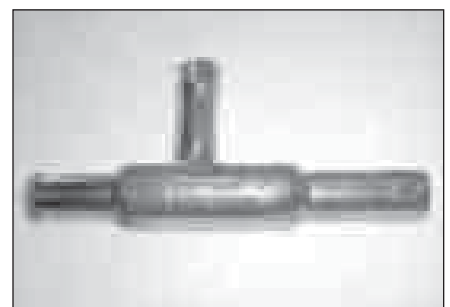

Valve, Crankcase

Order Part #: P-14-00205-00
(Replaces Carrier #: 14-00205-00)



Valve, Pres. Reg.

Order Part #: P-14-60000-01
(Replaces Carrier #: 14-60000-01)



Valve, Pres. Reg

Order Part #: P-14-60000-00
(Replaces Carrier #: 14-60000-00)

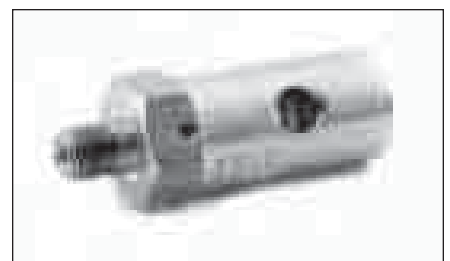

Valve, Pressure Relief

Order Part #: P-14-01109-00
(Replaces Carrier #: 14-01109-00)

Truck & Trailer Parts – REFRIGERATION

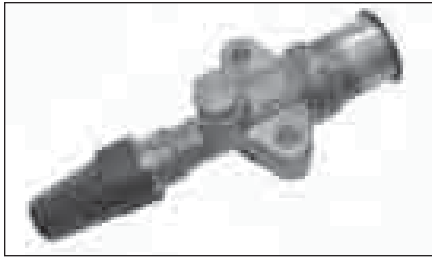

Valve, Service 1-1/8"

Order Part #: P-14-01042-06
(Replaces Carrier #: 14-01042-06)

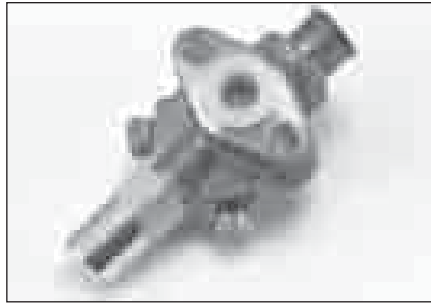

Valve, Service

Order Part #: P-14-60023-01
(Replaces Carrier #: 14-60023-01)

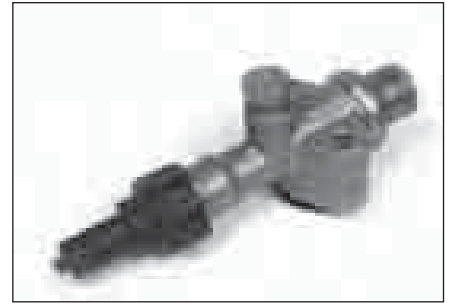

Valve, Service 7/8"

Order Part #: P-14-01042-04
(Replaces Carrier #: 14-01042-04)



Valve, Solenoid w/o Coil

Order Part #: P-14-00269-01
(Replaces Carrier #: 14-00269-01)



Valve, Solenoid (HGS2)

Order Part #: P-14-00276-01
(Replaces Carrier #: 14-00276-01)

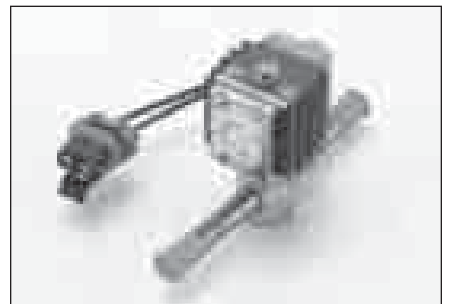

Valve, Solenoid

Order Part #: P-14-60051-00
(Replaces Carrier #: 14-60051-00)



Valve, Solenoid

Order Part #: P-14-60062-00
(Replaces Carrier #: 14-60062-00)

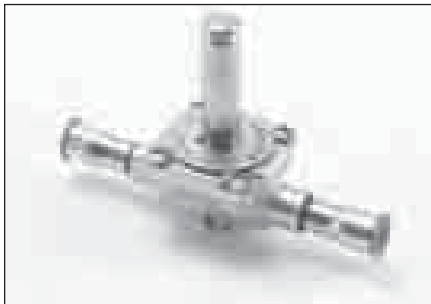

Valve, w/ Inlet Bell

Order Part #: P-14-60024-00
(Replaces Carrier #: 14-60024-00)



Vibrasorber, Discharge '99

Order Part #: P-73-60010-03
(Replaces Carrier #: 73-60010-03)



Vibrasorber, Discharge

Order Part #: P-73-00326-00
(Replaces Carrier #: 73-00326-00)



Vibrasorber, Discharge

Order Part #: P-73-00326-01
(Replaces Carrier #: 73-00326-01)

Truck & Trailer Parts – REFRIGERATION



Vibrasorber, Discharge

Order Part #: P-73-00328-05
(Replaces Carrier #: 73-00328-05)

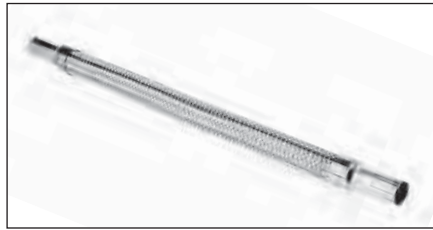

Vibrasorber, Discharge

Order Part #: P-73-00328-00
(Replaces Carrier #: 73-00328-00)

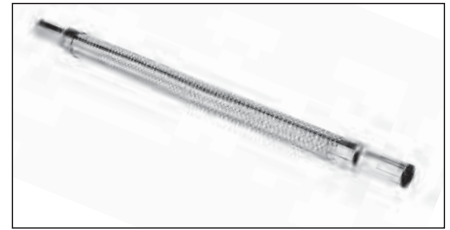

Vibrasorber, Discharge

Order Part #: P-73-00328-01
(Replaces Carrier #: 73-00328-01)



Vibrasorber, Discharge

Order Part #: P-73-60010-00
(Replaces Carrier #: 73-60010-00)



Vibrasorber, Discharge

Order Part #: P-73-60010-02
(Replaces Carrier #: 73-60010-02)



Vibrasorber, Suc/Dis

Order Part #: P-73-00328-03
(Replaces Carrier #: 73-00328-03)



Vibrasorber, Suction

Order Part #: P-151792
(Replaces Carrier #: 151792)

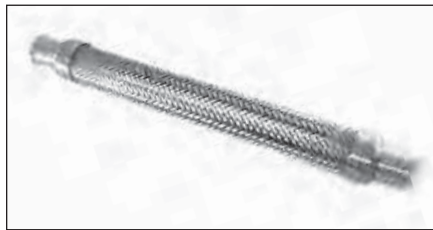

Vibrasorber, Suction

Order Part #: P-7102273
(Replaces Carrier #: 7102273)

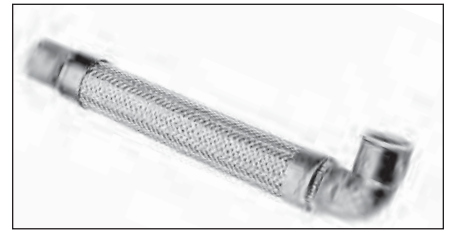

Vibrasorber, Suction

Order Part #: P-73-00325-00
(Replaces Carrier #: 73-00325-00)



Vibrasorber, Suction

Order Part #: P-73-00325-01
(Replaces Carrier #: 73-00325-01)

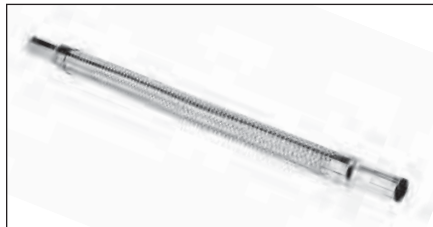

Vibrasorber, Suction

Order Part #: P-73-00328-02
(Replaces Carrier #: 73-00328-02)



Vibrasorber, Suction

Order Part #: P-73-60024-00
(Replaces Carrier #: 73-60024-00)

EON IS HERE!



Introducing a long-life dry cell battery that features a full-replacement, four-year warranty!

Thermo King is proud to announce the new EON battery – a dry cell battery that boasts greater efficiency, a lower life cycle cost and a longer life than wet cell batteries. Plus, the battery features a full-replacement four-year warranty.

Dry Cell Technology

The EON battery uses Absorbed Glass Mat (AGM) technology to offer, in one box, the characteristics of two separate batteries. It can deep cycle as well as provide enormous cranking power in one durable package. The five-second cranking power of the EON is double to triple that of equally sized conventional batteries, even at extremely low temperatures. The EON also features a 200-minute reserve capacity.

Greater Value

Because the EON lasts 3 to 5 times longer than a wet cell battery, users will be buying significantly fewer batteries. Plus, the EON can help reduce fuel costs because less engine run time is required to recharge the battery when the refrigeration unit is in CYCLE-SENTRY™ mode.

Outstanding Durability

The EON has a rated operating temperature of up to 180 degrees F, and, with its vibration-resistant construction, is ideal for demanding applications. Because of its dry-cell technology, the EON will never leak and features corrosion-free terminals.

Starting Power at -4°F

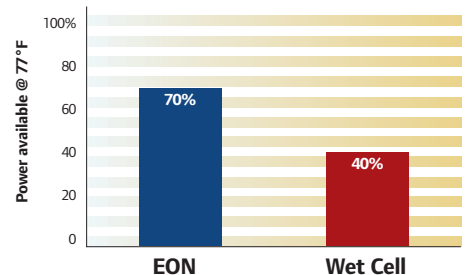

Part Numbers

**203-550 Threaded Stud
203-551 SAE Post**

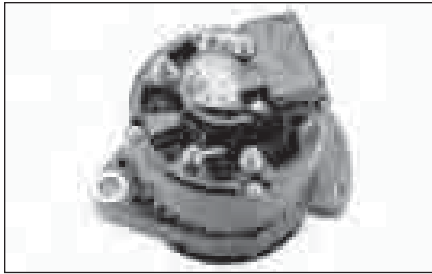

Alternator (65A)

Order Part #: P-30-00423-00
(Replaces Carrier #: 30-00423-00)

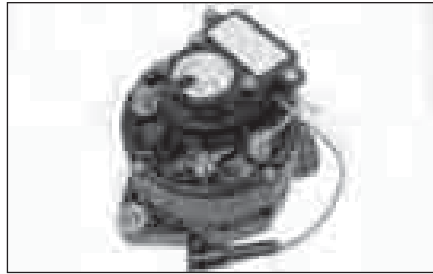

**Alternator, 105 Amp
(less pulley)**

Order Part #: P-30-00409-11
(Replaces Carrier #: 30-00409-11)

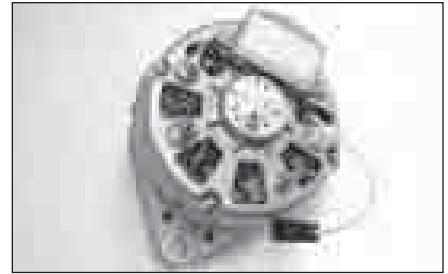

Alternator, 37 Amp

Order Part #: P-30-50324-00
(Replaces Carrier #: 30-50324-00)

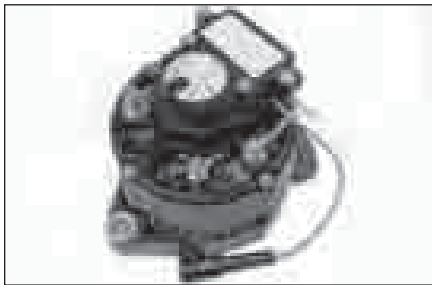

Alternator, 65 Amp (less pulley)

Order Part #: P-30-00409-10
(Replaces Carrier #: 30-00409-10)



Alternator, 65 Amp

Order Part #: P-30-00409-65
(Replaces Carrier #: 30-00409-65)

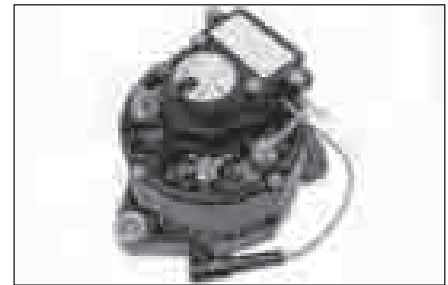

Alternator, 65 Amp (CW)

Order Part #: P-30-00393-00
(Replaces Carrier #: 30-00393-00)

**Alternator, 65 Amp
(less pulley) REMAN.**

Order Part #: P-30-00409-10RM
(Replaces Carrier #: 30-00409-10RM)



**Alternator, 65 Amp
(w/ pulley)**

Order Part #: P-30-50326-00
(Replaces Carrier #: 30-50326-00)



Alternator, 70 Amp

Order Part #: P-30-60050-04
(Replaces Carrier #: 30-60050-04)

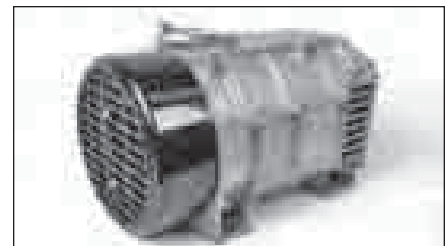

Generator

Order Part #: P-54-00136-05
(Replaces Carrier #: 54-00136-05)

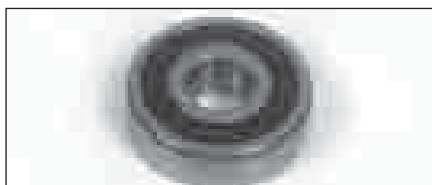

Bearing, Alt. Rear

Order Part #: P-04-60008-04
(Replaces Carrier #: 04-60008-04)

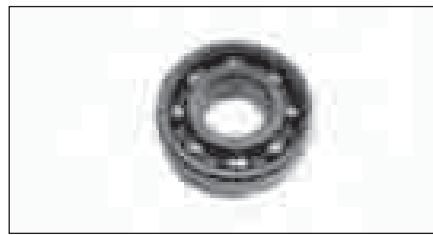

Bearing, Alternator

Order Part #: P-04-60008-24
(Replaces Carrier #: 04-60008-24)

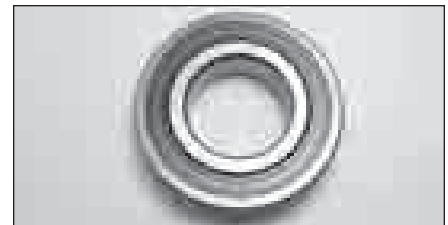

Bearing, Motor

Order Part #: P-04-60008-32
(Replaces Carrier #: 04-60008-32)

Bearing, Motor

Order Part #: P-04-60008-34
(Replaces Carrier #: 04-60008-34)

ELECTRICAL

Truck & Trailer Parts – ELECTRICAL

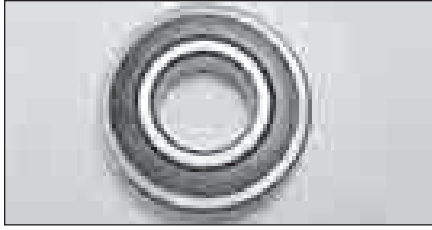

Bearing, Motor, Front

Order Part #: P-160165
(Replaces Carrier #: 160165)

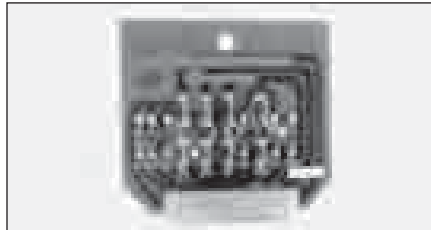

Board, Diode

Order Part #: P-22-01102-10
(Replaces Carrier #: 22-01102-10)

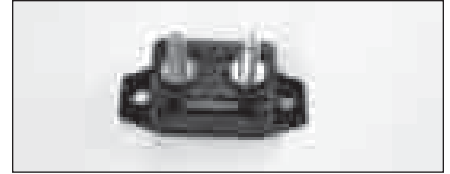

Breaker, Circuit (20A)

Order Part #: P-10-00171-03
(Replaces Carrier #: 10-00171-03)

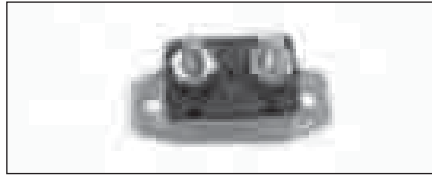

Breaker, Circuit (CB-2, 25A)

Order Part #: P-10-00171-09
(Replaces Carrier #: 10-00171-09)



Brush & Cap

Order Part #: P-54-60006-30SV
(Replaces Carrier #: 54-60006-30SV)

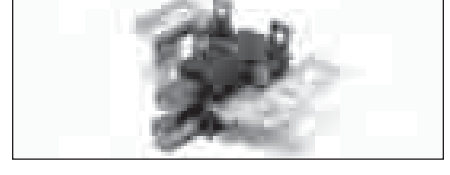

Brush Assem., Alternator

Order Part #: P-30-00409-30
(Replaces Carrier #: 30-00409-30)



Brush Assy

Order Part #: P-30-00363-25
(Replaces Carrier #: 30-00363-25)

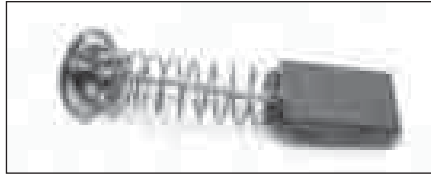

Brush Assy., (rear evap fan motor)

Order Part #: P-16-02527-00
(Replaces Carrier #: 16-02527-00)



Cable, Cab Command

Order Part #: P-22-60013-00
(Replaces Carrier #: 22-60013-00)

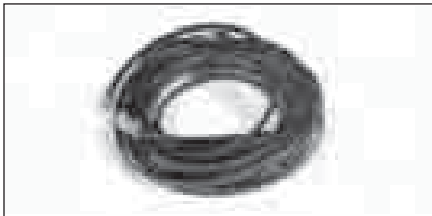

Cable, Cab Command

Order Part #: P-22-60551-00
(Replaces Carrier #: 22-60551-00)



Cable, Ribbon

Order Part #: P-22-01641-00
(Replaces Carrier #: 22-01641-00)



Cap, Switch

Order Part #: P-58-60158-00
(Replaces Carrier #: 58-60158-00)

**Boots for Speed and Starter Solenoids are in
the Engine Section with the Solenoids.**



Cap, Switch

Order Part #: P-58-60158-01
(Replaces Carrier #: 58-60158-01)

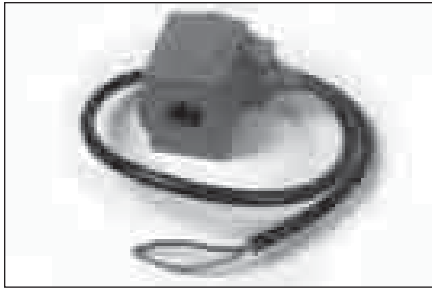

Coil, Solenoid 12V
 Order Part #: P-22-60268-00
 (Replaces Carrier #: 22-60268-00)

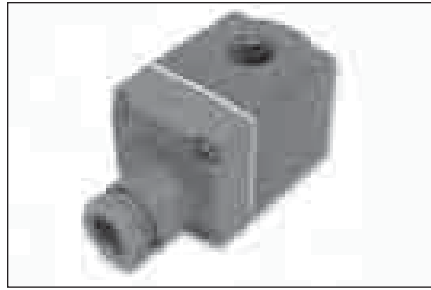

Coil, Solenoid 12V
 Order Part #: P-22-60307-00
 (Replaces Carrier #: 22-60307-00)

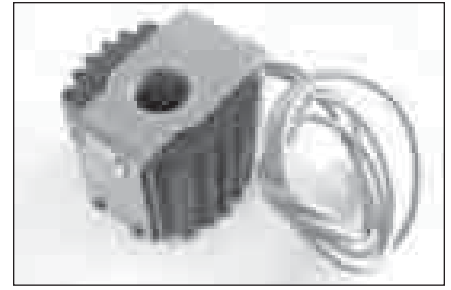

Coil, Solenoid (24VDC)
 Order Part #: P-14-01091-02
 (Replaces Carrier #: 14-01091-02)

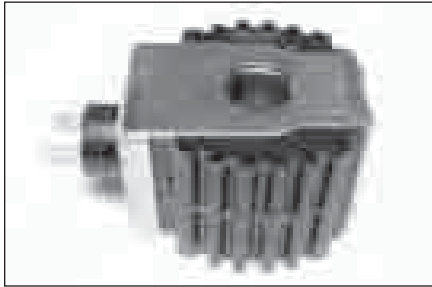

Coil, Solenoid (SV-1)
 Order Part #: P-14-00147-05
 (Replaces Carrier #: 14-00147-05)

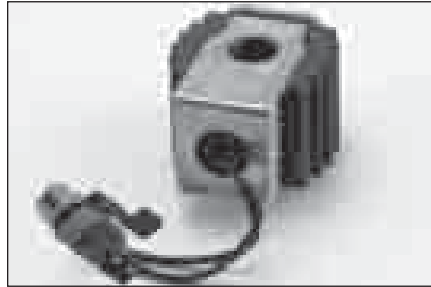

Coil, Solenoid (SV-1)
 Order Part #: P-14-01114-20
 (Replaces Carrier #: 14-01114-20)

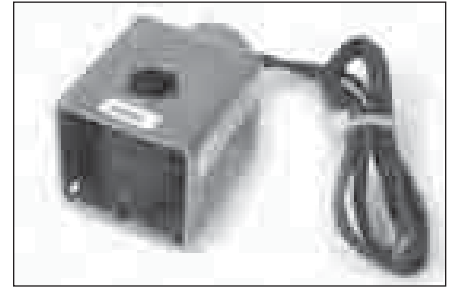

Coil, Solenoid (SV-2/SV-4)
 Order Part #: P-22-02567-00
 (Replaces Carrier #: 22-02567-00)

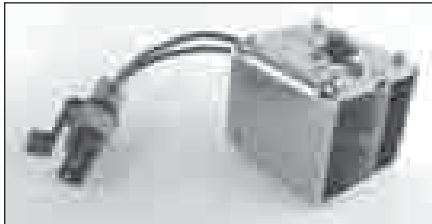

Coil, Solenoid (SV-2/SV-4)
 Order Part #: P-22-02579-00
 (Replaces Carrier #: 22-02579-00)

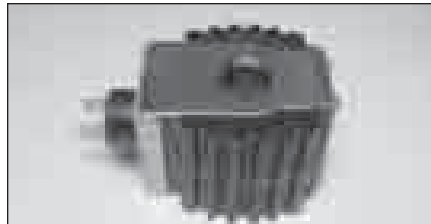

Coil, Solenoid (SV-3)
 Order Part #: P-14-00145-03
 (Replaces Carrier #: 14-00145-03)



Coil, Solenoid (3-Way Valve)
 Order Part #: P-14-01110-01
 (Replaces Carrier #: 14-01110-01)



Capacitor
 Order Part #: P-10-60040-05
 (Replaces Carrier #: 10-60040-05)



Capacitor
 Order Part #: P-10-60047-03
 (Replaces Carrier #: 10-60047-03)



Capacitor (40 MF)
 Order Part #: P-10-60047-00
 (Replaces Carrier #: 10-60047-00)

Truck & Trailer Parts – ELECTRICAL

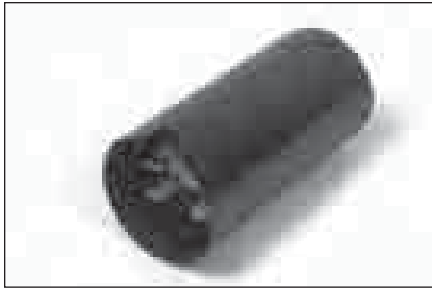

**Capacitor
350 MFD @ 165/205V**
Order Part #: P-10-60048-06
(Replaces Carrier #: 10-60048-06)



Capacitor 60MFD @ 450V
Order Part #: P-10-60047-05
(Replaces Carrier #: 10-60047-05)



Capacitor, 63V 22000 MFD
Order Part #: P-10-60040-01
(Replaces Carrier #: 10-60040-01)



Capacitor, Start (150MF)
Order Part #: P-10-60048-03
(Replaces Carrier #: 10-60048-03)



Capacitor, Start (200MF)
Order Part #: P-10-60048-05
(Replaces Carrier #: 10-60048-05)



Capacitor
Order Part #: P-54-00136-24
(Replaces Carrier #: 54-00136-24)



Capacitor 4 MFD@400V
ORDER PART #: P-10-60038-00
(Replaces Carrier #: 10-60038-00)



Capacitor 50 MFD@230V
ORDER PART #: P-10-60038-12
(Replaces Carrier #: 10-60038-12)



Contactor
Order Part #: P-10-00433-00
(Replaces Carrier #: 10-00433-00)

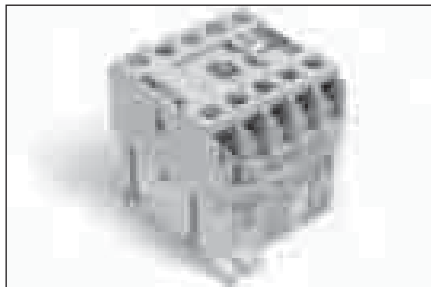

Contactor
Order Part #: P-12-60044-05
(Replaces Carrier #: 12-60044-05)

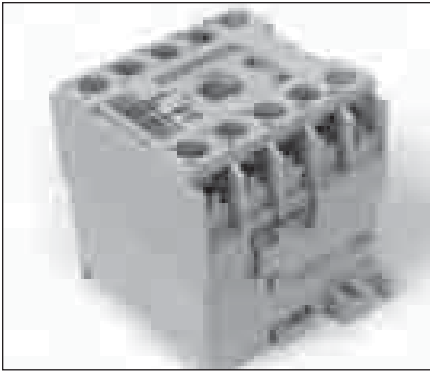

Contactor

Order Part #: P-12-60044-01
(Replaces Carrier #: 12-60044-01)

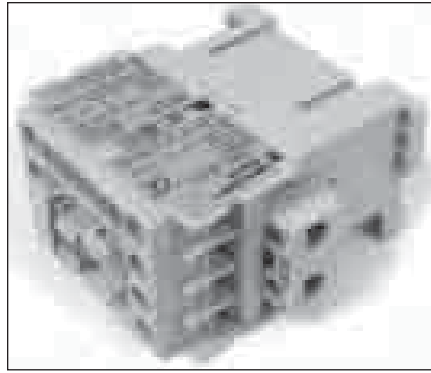

Contactor, 3 Pole

Order Part #: P-10-00391-20
(Replaces Carrier #: 10-00391-20)

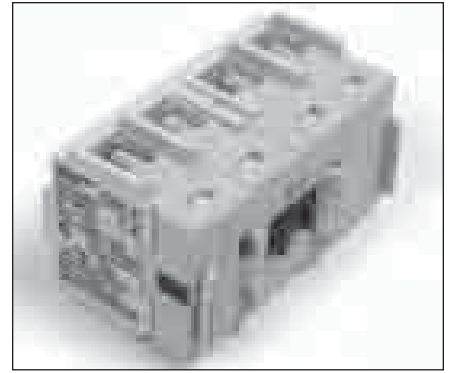

Contactor

Order Part #: P-10-60043-00
(Replaces Carrier #: 10-60043-00)

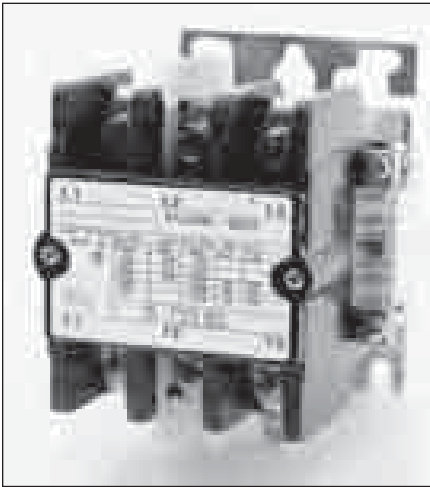

Contactor, 4 Pole (40A)

Order Part #: P-10-00279-00
(Replaces Carrier #: 10-00279-00)



Control, Fan Cycling

Order Part #: P-101-1025
(Replaces Carrier #: 101-1025)



Diode

Order Part #: P-12-60049-00
(Replaces Carrier #: 12-60049-00)

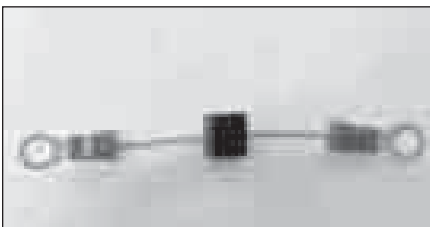

Diode (6A)

Order Part #: P-22-01030-17
(Replaces Carrier #: 22-01030-17)

Truck & Trailer Parts – ELECTRICAL

Harness, Transducer
 Order Part #: P-22-04036-00SV
 (Replaces Carrier #: 22-04036-00SV)

ALSO AVAILABLE

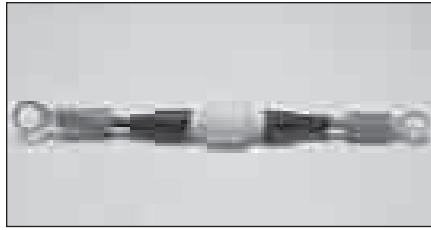

Diode, Solenoid
 Order Part #: P-136854
 (Replaces Carrier #: 136854)

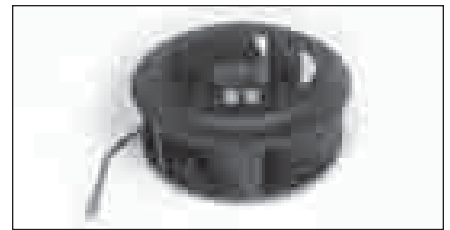

Fan, Motor Thin Line Evap
 Order Part #: P-54-60022-08
 (Replaces Carrier #: 54-60022-08)

ELECTRICAL

MASTER FUSE CHART		Description	Advantage	Eagle	Extra	Optima	TBird	Ulma	Ultra	EuroPhoenix	Maxima	Supra 922/944	Supra 722/744	Supra 622/644	Supra 422	Supra 322	Integra 30S	Integra 40S	Integra 50S	Solara
P-12-00526-88 Replaces Carrier #12-00526-88	Fuse 1A Time Delay																	X	X	
P-22-60102-05 Replaces Carrier #22-60102-05	Fuse 3.15A (For 3 PH)																	X	X	
P-22-60340-01 Replaces Carrier #22-60340-01	Fuse 50 AMP																	X	X	
P-22-60102-07 Replaces Carrier #22-60102-07	Fuse 6.3A																	X	X	
P-22-60543-06 Replaces Carrier #22-60543-06	Fuse, 10A																	X	X	
P-22-02336-16 Replaces Carrier #22-02336-16	Fuse, 40 Amp																X			
P-22-60340-04 Replaces Carrier #22-60340-04	Fuse, 80 Amp														X	X				
P-22-02336-03 Replaces Carrier #22-02336-03	Fuse, Blade (3A)	X				X				X	X									
P-22-02336-04 Replaces Carrier #22-02336-04	Fuse, Blade (10A)	X		X	X	X	X	X	X	X			X		X					
P-22-02336-06 Replaces Carrier #22-02336-06	Fuse, Blade (15A)	X		X	X			X	X		X	X	X	X	X					
P-22-02336-01 Replaces Carrier #22-02336-01	Fuse, Blade (20A)	X	X	X	X	X	X	X	X		X	X	X	X	X					
P-22-02336-05 Replaces Carrier #22-02336-05	Fuse, Blade (25A)	X		X	X	X	X	X	X	X	X	X	X	X	X					
P-22-02336-00 Replaces Carrier #22-02336-00	Fuse, Blade (30A)	X	X			X				X	X									
P-22-02336-02 Replaces Carrier #22-02336-02	Fuse, Blade (5A)	X	X	X	X	X	X	X	X	X	X	X	X	X	X					
P-22-02336-08 Replaces Carrier #22-02336-08	Fuse, Blade (7.5A)	X		X	X			X	X		X									
P-22-02336-09 Replaces Carrier #22-02336-09	Fuse, Blade (80A)	X		X	X			X	X		X	X	X	X	X					X
P-22-00060-03 Replaces Carrier #22-00060-03	Fuse, Glass (15A)		X	X					X											
P-22-00060-16 Replaces Carrier #22-00060-16	Fuse, Glass (2A)		X																	
P-22-00060-20 Replaces Carrier #22-00060-20	Fuse, Glass, 1" (3A)					X														

Truck & Trailer Parts – ELECTRICAL

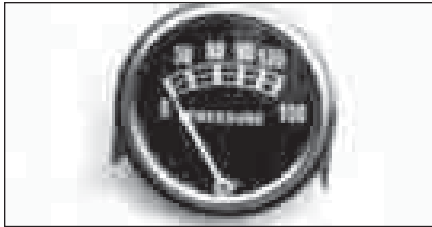

Gauge, Oil Pressure

Order Part #: P-12-00011-00
(Replaces Carrier #: 12-00011-00)



Gauge, Suction Pressure

Order Part #: P-12-00003-00
(Replaces Carrier #: 12-00003-00)



Gauge, Water Temp

Order Part #: P-12-00097-03
(Replaces Carrier #: 12-00097-03)

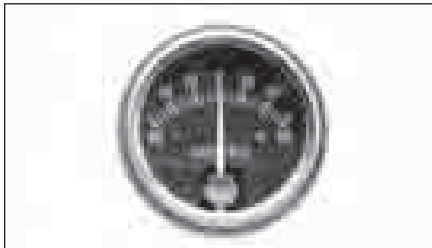

Gauge, Ammeter (+60A/-60A)

Order Part #: P-22-00538-01SV
(Replaces Carrier #: 22-00538-01SV)

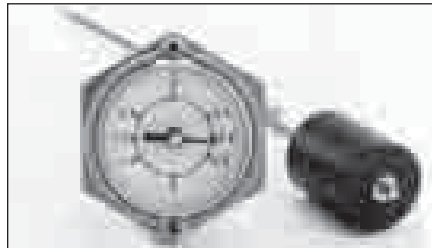

Gauge, Fuel (w/Float & Arm)

Order Part #: P-12-00104-99
(Replaces Carrier #: 12-00104-99)

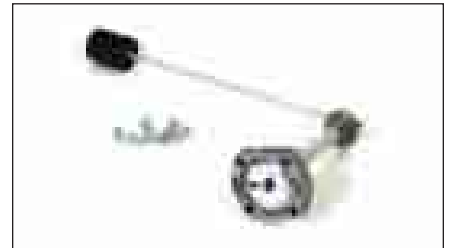

Gauge, Fuel

Order Part #: 112-501
(Replaces Carrier #: 12-01141-00)

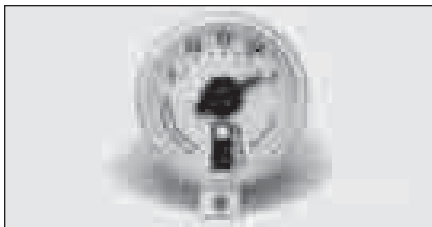

Dial, Fuel Gauge

Order Part #: P-12-01141-20
(Replaces Carrier #: 12-01141-20)



Harness, Alternator

Order Part #: P-22-60365-01SV
(Replaces Carrier #: 22-60365-01SV)



Harness, Cab Command

Order Part #: P-22-02624-00
(Replaces Carrier #: 22-02624-00)



Dial, Fuel Gauge

Order Part #: P-12-00104-03
(Replaces Carrier #: 12-00104-03)



Harness, Cab Command

Order Part #: P-22-60342-00
(Replaces Carrier #: 22-60342-00)

Truck & Trailer Parts – ELECTRICAL

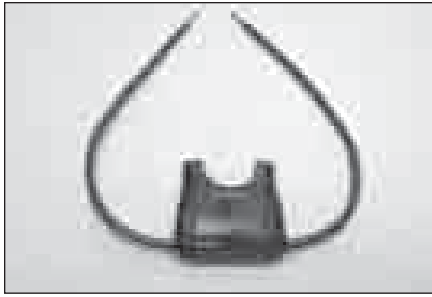

Holder, Fuse

Order Part #: P-22-60313-00
(Replaces Carrier #: 22-60313-00)



Keypad, Micro Display (Reman) For Standard or Summit micros on Ultra, Ultima and Extra

Order Part #: P-12-00307-00SVRM
(Replaces Carrier #: 12-00307-00SVRM)

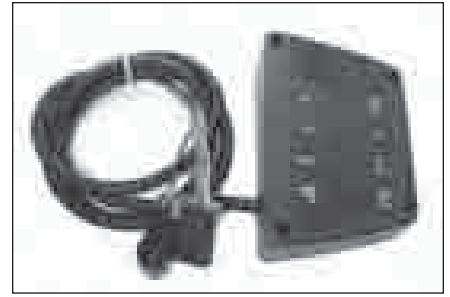

Light Bar Assembly

Order Part #: P-76-00542-00
(Replaces Carrier #: 76-00542-00)



Motor (PG), Evaporator Fan

Order Part #: P-54-60006-13-B
(Replaces Carrier #: 54-60006-13)

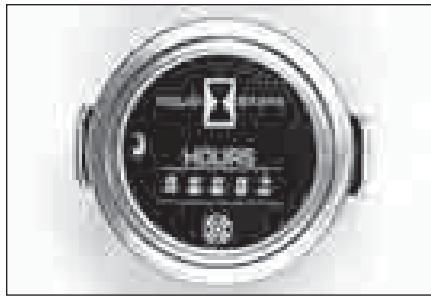

Meter, Hour

Order Part #: P-10-01165-00
(Replaces Carrier #: 10-01165-00)

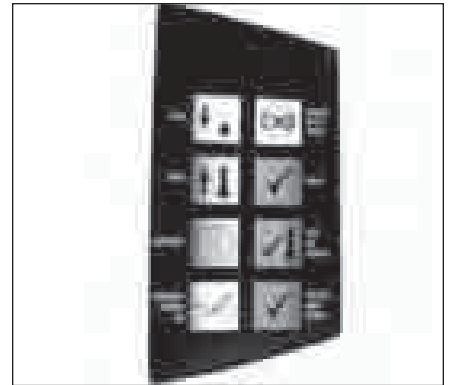

Decal, Light Bar

Order Part #: P-22-01465-53
(Replaces Carrier #: 22-01465-53)

**NOTE: Brush & Cap shown
below are only for PG
Motor above.**



Brush Set for PG Motor

Order Part #: P-54-60006-30PG
Not available from Carrier



Cap, Brush for PG Motor

Order Part #: P-54-60006-31PG
Not available from Carrier



Meter, Volt

Order Part #: P-133234
(Replaces Carrier #: 133234)

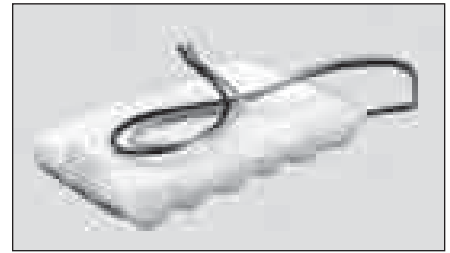

Pack, Battery

Order Part #: P-30-00407-02SV
(Replaces Carrier #: 30-00407-02SV)



Plug, Power

Order Part #: 411-816
(Replaces Carrier #: 22-01131-03)



Plug, Power

Order Part #: P-22-01513-00
(Replaces Carrier #: 22-01513-00)



**Probe, Thermistor
(Eng Temp)**

Order Part #: P-12-00312-03
(Replaces Carrier #: 12-00312-03)



Probe, Thermistor

Order Part #: P-12-01145-03
(Replaces Carrier #: 12-01145-03)

**LOOKING FOR GLOW
PLUGS?
THEY CAN BE FOUND IN
THE ENGINE SECTION.**

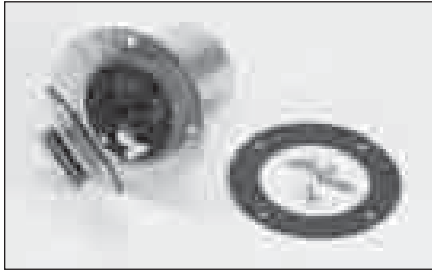

Receptacle, 250V/3PH/50A

Order Part #: P-22-01132-03
(Replaces Carrier #: 22-01132-03)

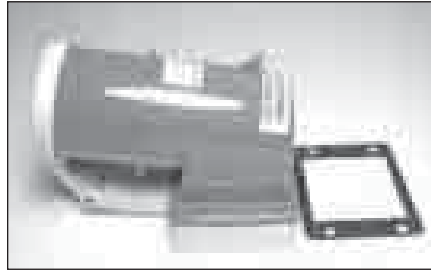

Receptacle, Power

Order Part #: P-22-01512-00
(Replaces Carrier #: 22-01512-00)



Rectifier, Charging System

Order Part #: P-10-01120-00
(Replaces Carrier #: 10-01120-00)

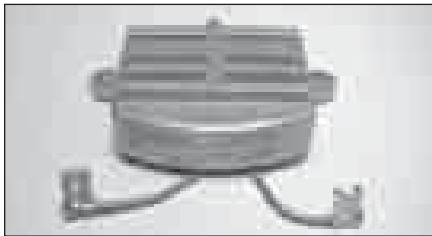

Regulator

Order Part #: P-133281
(Replaces Carrier #: 133281)

Regulator
Order Part #: P-30-60050-20
(Replaces Carrier #: 30-60050-20)

ALSO AVAILABLE

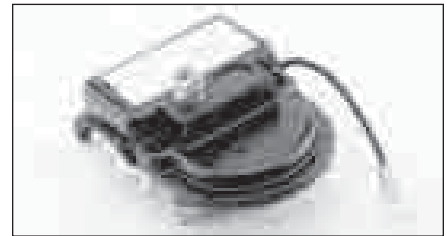

Regulator, Voltage

Order Part #: P-30-00423-02
(Replaces Carrier #: 30-00423-02)

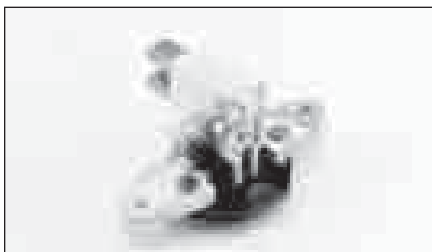

Regulator, Voltage

Order Part #: P-30-00393-30
(Replaces Carrier #: 30-00393-30)



Regulator, Voltage

Order Part #: P-30-00409-44
(Replaces Carrier #: 30-00409-44)

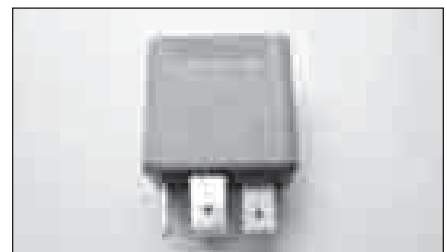

Relay

Order Part #: P-10-00286-07
(Replaces Carrier #: 10-00286-07)

ELECTRICAL

Truck & Trailer Parts – ELECTRICAL

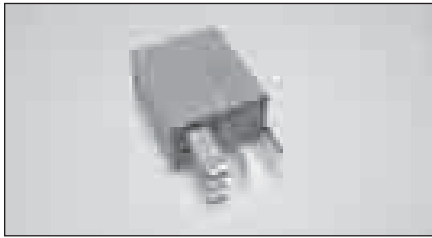

Relay (20 Amp)

Order Part #: P-10-00385-00
(Replaces Carrier #: 10-00385-00)

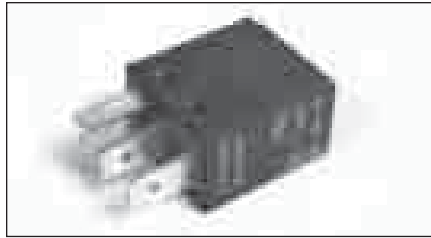

Relay

Order Part #: P-10-00385-02
(Replaces Carrier #: 10-00385-02)

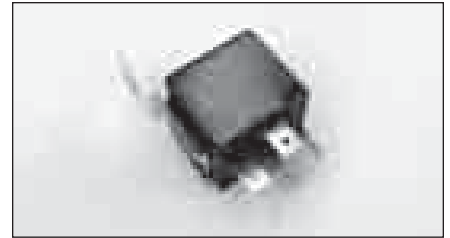

Relay (SP, DT, NC, w/Diode)

Order Part #: P-10-00286-02
(Replaces Carrier #: 10-00286-02)

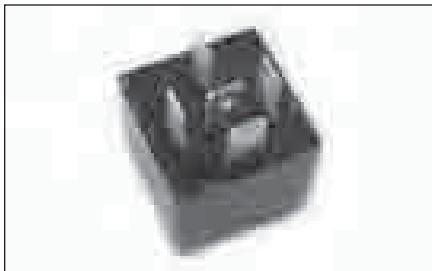

Relay, (40A, 12V)

Order Part #: P-10-00286-04
(Replaces Carrier #: 10-00286-04)



Relay, (70A)

Order Part #: P-10-00328-00
(Replaces Carrier #: 10-00328-00)

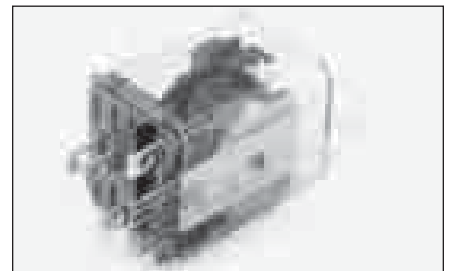

Relay, Glow Plug

Order Part #: P-10-00281-00
(Replaces Carrier #: 10-00281-00)



Relay, Mtr Overload

Order Part #: P-133256
(Replaces Carrier #: 133256)

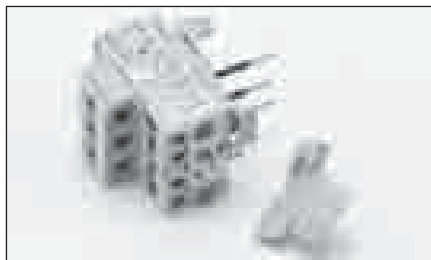

Relay, Overload

Order Part #: P-10-60044-00
(Replaces Carrier #: 10-60044-00)

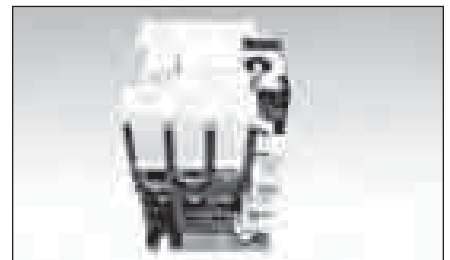

Relay, Overload

Order Part #: P-10-60049-00
(Replaces Carrier #: 10-60049-00)

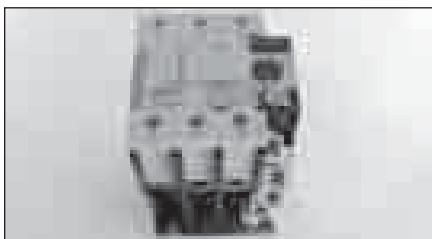

Relay, Overload

Order Part #: P-10-60049-01
(Replaces Carrier #: 10-60049-01)

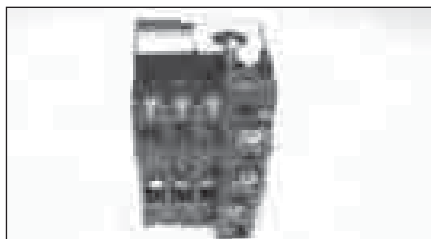

Relay, Overload

Order Part #: P-10-60056-00
(Replaces Carrier #: 10-60056-00)



Relay, Overload

Order Part #: P-12-60010-00
(Replaces Carrier #: 12-60010-00)

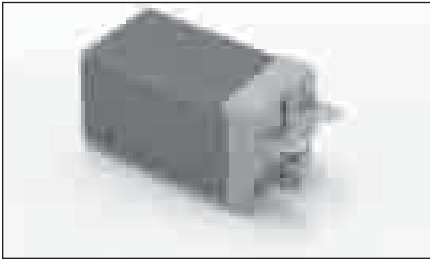

Relay, Start 115V

Order Part #: P-10-60012-01
(Replaces Carrier #: 10-60012-01)



Relay, Start (230V)

Order Part #: P-10-60012-00
(Replaces Carrier #: 10-60012-00)



Relay, Start, 230V Single PH

Order Part #: P-10-00424-01
(Replaces Carrier #: 10-00424-01)

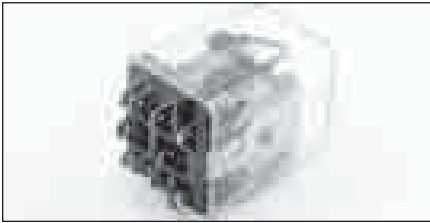

Relay, Starter Solenoid (12V)

Order Part #: P-10-00220-00
(Replaces Carrier #: 10-00220-00)

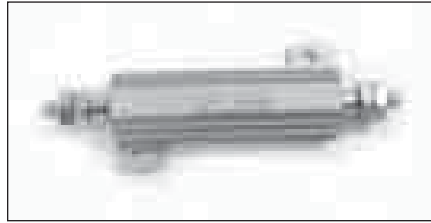

Resistor (50W)

Order Part #: P-22-01427-00
(Replaces Carrier #: 22-01427-00)

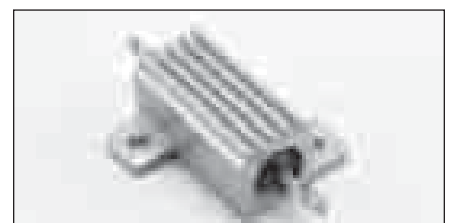

Resistor, 68 OHMS

Order Part #: P-22-60184-00
(Replaces Carrier #: 22-60184-00)

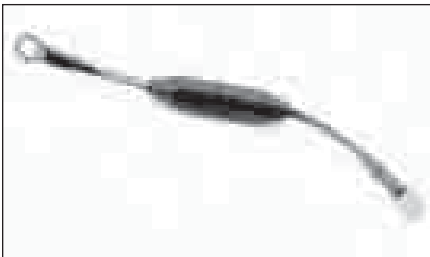

Resistor, Alternator

Order Part #: P-30-00393-35
(Replaces Carrier #: 30-00393-35)

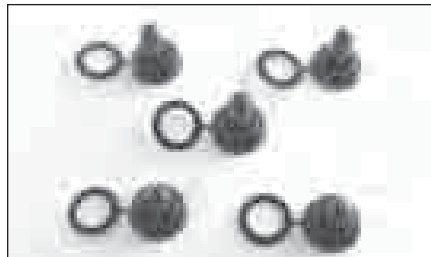

Seal, Boot

Order Part #: P-66U2-1081
(Replaces Carrier #: 66U2-1081)



Selector, Temp (F)

Order Part #: P-22-01189-00SV
(Replaces Carrier #: 22-01189-00SV)



Sender, Oil Pressure

Order Part #: P-12-00258-01
(Replaces Carrier #: 12-00258-01)



Sensor

Order Part #: P-22-60167-00
(Replaces Carrier #: 22-60167-00)

Truck & Trailer Parts – ELECTRICAL



Sensor (SAS)

Order Part #: P-22-01636-00
(Replaces Carrier #: 22-01636-00)

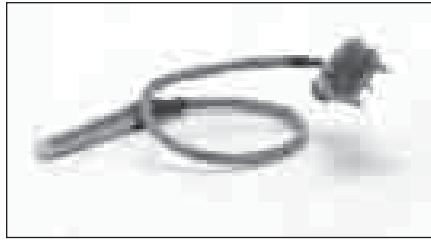

Sensor RAS

Order Part #: P-12-60001-20
(Replaces Carrier #: 12-60001-20)

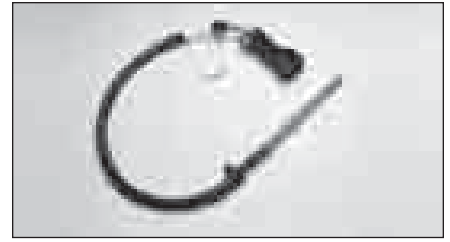

Sensor (RAS)

Order Part #: P-22-01940-00
(Replaces Carrier #: 22-01940-00)



Sensor, Combination

Order Part #: P-12-00500-01SV
(Replaces Carrier #: 12-00500-01SV)



Sensor, Digital (TH)

Order Part #: P-12-01075-01
(Replaces Carrier #: 12-01075-01)



Sensor, RPM

Order Part #: P-12-00448-01
(Replaces Carrier #: 12-00448-01)

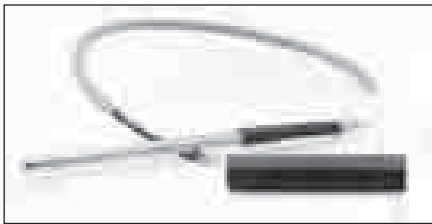

Sensor, Thermostat

Order Part #: P-12-01072-11SV
(Replaces Carrier #: 12-01072-11SV)

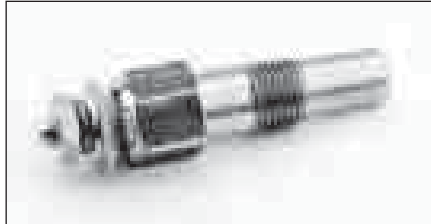

Sensor, Water Temp

Order Part #: P-12-00257-00
(Replaces Carrier #: 12-00257-00)



Switch, Air Pressure

Order Part #: P-12-01039-08
(Replaces Carrier #: 12-01039-08)

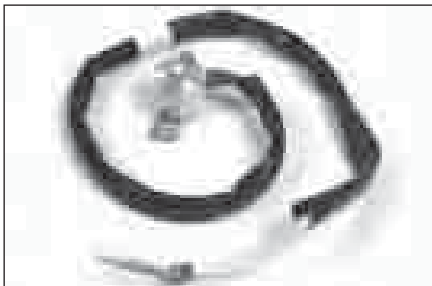

Switch, Defrost Termination

Order Part #: P-14-60055-00
(Replaces Carrier #: 14-60055-00)



Switch, HPCO (HP-1) R22

Order Part #: P-12-00309-01
(Replaces Carrier #: 12-00309-01)

***STARTERS AND SOLENOIDS CAN BE FOUND
IN THE ENGINE SECTION.***

Truck & Trailer Parts – ELECTRICAL

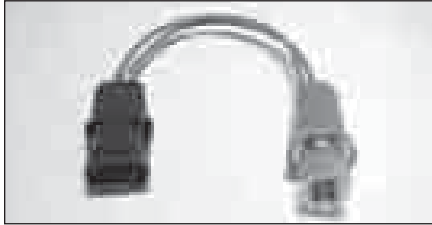

Switch, Pressure

Order Part #: P-12-60015-01
(Replaces Carrier #: 12-60015-01)

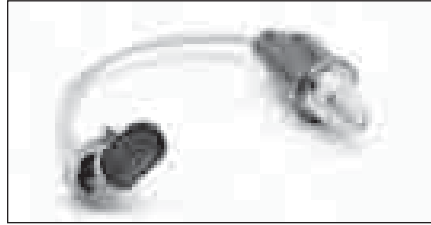

Switch, Pressure (350PSIG, HPS)

Order Part #: P-12-00309-00
(Replaces Carrier #: 12-00309-00)

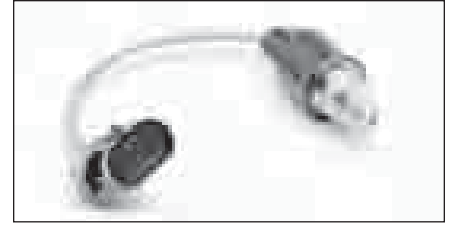

Switch, Pressure (489 PSIG, HP-1)

Order Part #: P-12-00309-04
(Replaces Carrier #: 12-00309-04)



Switch, Pressure (HP-1)

Order Part #: P-12-00255-00
(Replaces Carrier #: 12-00255-00)

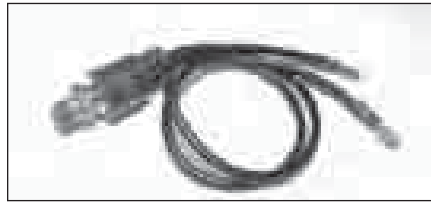

Switch, Pressure (HP-1)

Order Part #: P-66U1-6942-1
(Replaces Carrier #: 66U1-6942-1)



Switch, Pressure (HP-2)

Order Part #: P-12-00299-16
(Replaces Carrier #: 12-00299-16)



Switch, Pressure (HP-2)

Order Part #: P-12-01012-00
(Replaces Carrier #: 12-01012-00)

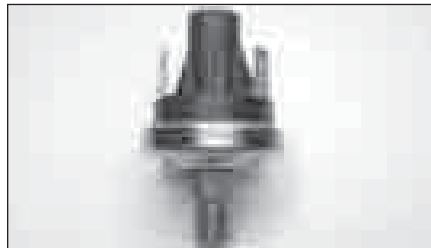

Switch, Pressure (Oil)

Order Part #: P-10-00316-00
(Replaces Carrier #: 10-00316-00)

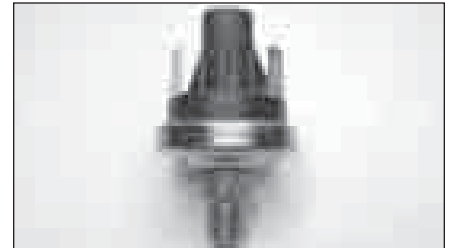

Switch, Pressure (Oil)

Order Part #: P-10-01169-00
(Replaces Carrier #: 10-01169-00)



Switch, Pressure (Oil)

Order Part #: P-10-01169-01
(Replaces Carrier #: 10-01169-01)



Switch, Pressure (Oil)

Order Part #: P-12-00592-00
(Replaces Carrier #: 12-00592-00)

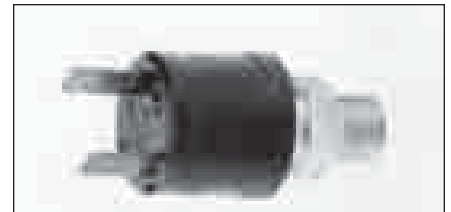

Switch, Pressure

Order Part #: P-12-00254-00
(Replaces Carrier #: 12-00254-00)



Switch, Pressure, Head (HP-2)

Order Part #: P-12-00255-02
(Replaces Carrier #: 12-00255-02)

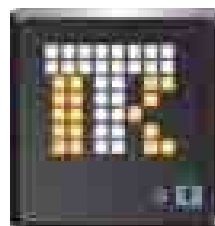

Status Light, LED

Order Part #: P-76-02000-00
(Replaces Carrier #: 76-02000-00)

Wiring Harness for Standard /Summit

Order Part #: P-22-02843-00
(Replaces Carrier #: 22-02843-00)

Truck & Trailer Parts – ELECTRICAL

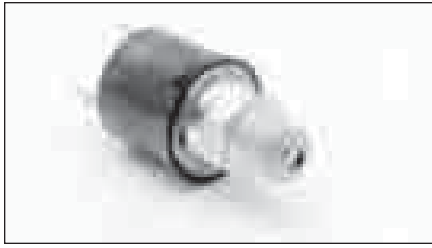

Switch, Pressure

Order Part #: P-12-00254-01
(Replaces Carrier #: 12-00254-01)

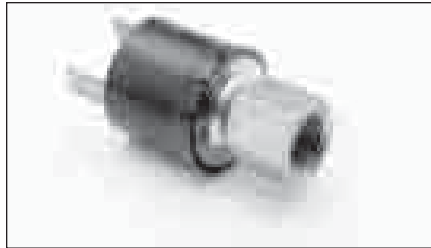

Switch, Pressure

Order Part #: P-12-00255-01
(Replaces Carrier #: 12-00255-01)



Switch, Pressure

Order Part #: P-12-00255-03
(Replaces Carrier #: 12-00255-03)



Switch, Pressure

Order Part #: P-12-01022-01
(Replaces Carrier #: 12-01022-01)

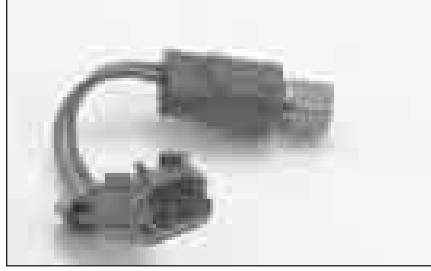

Switch, Pressure

Order Part #: P-12-60032-00
(Replaces Carrier #: 12-60032-00)

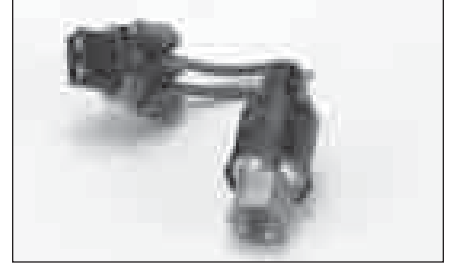

Switch, Pressure

Order Part #: P-12-60032-01
(Replaces Carrier #: 12-60032-01)

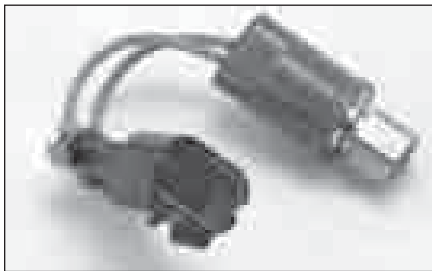

Switch, Pressure

Order Part #: P-12-60032-02
(Replaces Carrier #: 12-60032-02)



Switch, Start/Stop

Order Part #: P-22-02751-00
(Replaces Carrier #: 22-02751-00)

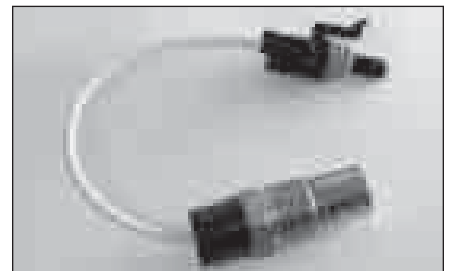

Switch, Temperature (Water)

Order Part #: P-12-60000-00
(Replaces Carrier #: 12-60000-00)



Switch, Thermostat (HTT)

Order Part #: P-66U1-6912-3
(Replaces Carrier #: 66U1-6912-3)



Switch, Thermostat

Order Part #: P-140507
(Replaces Carrier #: 140507)

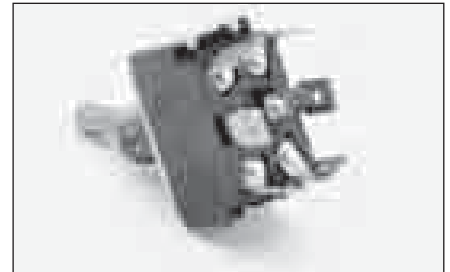

Switch, Toggle (Ele/Eng)

Order Part #: P-10-01129-06SV
(Replaces Carrier #: 10-01129-06SV)

Truck & Trailer Parts – ELECTRICAL



Switch, Toggle (Glow/Defrost)

Order Part #: P-10-01129-08SV
(Replaces Carrier #: 10-01129-08SV)

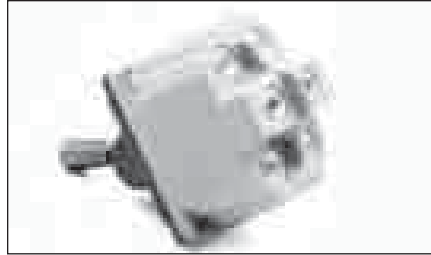

Switch, Toggle (GP)

Order Part #: P-10-00223-00
(Replaces Carrier #: 10-00223-00)



Switch, Toggle (Hi Air/Normal)

Order Part #: P-10-01129-02
(Replaces Carrier #: 10-01129-02)



Switch, Toggle (IGN)

Order Part #: P-10-00222-00
(Replaces Carrier #: 10-00222-00)



Switch, Toggle (ON/OFF)

Order Part #: P-10-00237-00
(Replaces Carrier #: 10-00237-00)



Switch, Toggle (RS)

Order Part #: P-10-01164-02
(Replaces Carrier #: 10-01164-02)

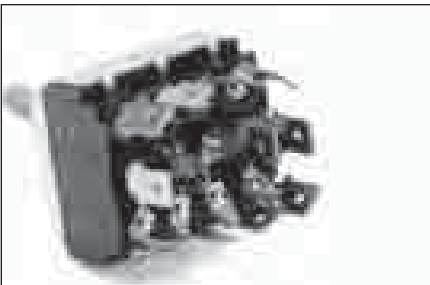

Switch, Toggle, On/Off (EB)

Order Part #: P-10-01129-07SV
(Replaces Carrier #: 10-01129-07SV)



Switch, Toggle

Order Part #: P-10-00327-00
(Replaces Carrier #: 10-00327-00)



Switch, Toggle

Order Part #: P-10-01129-01SV
(Replaces Carrier #: 10-01129-01SV)



Switch, Toggle

Order Part #: P-10-01129-15SV
(Replaces Carrier #: 10-01129-15SV)



Switch, Toggle

Order Part #: P-10-01129-04SV
(Replaces Carrier #: 10-01129-04SV)

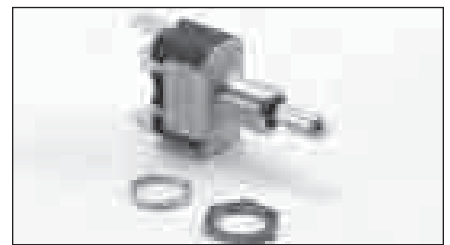

Switch, Toggle

Order Part #: P-10-01129-16SV
(Replaces Carrier #: 10-01129-16SV)

Truck & Trailer Parts – ELECTRICAL

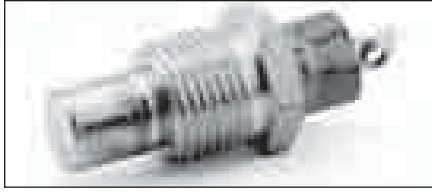

Switch, Water Temp (110C/230F)

Order Part #: P-10-00158-02
(Replaces Carrier #: 10-00158-02)

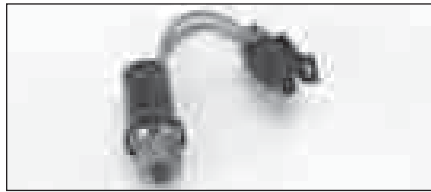

Swith, Low Pressure

Order Part #: P-12-60015-04
(Replaces Carrier #: 12-60015-04)

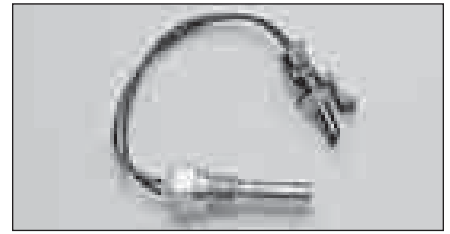

Thermistor, Comp Dis Temp (CDT)

Order Part #: P-12-00284-00
(Replaces Carrier #: 12-00284-00)



Thermistor, RAS/SAS (XL, XT, XTC)

Order Part #: P-12-00523-01
(Replaces Carrier #: 12-00523-01)

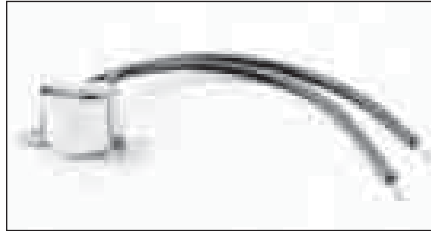

Thermostat, Def. Termination

Order Part #: P-12-00228-07
(Replaces Carrier #: 12-00228-07)



Thermometer, POCKET Dial (F)

Order Part #: P-T160

Thermometer, POCKET Dial (C)

Order Part #: P-TC70



Thermometer, POCKET Digital(C)

Order Part #: P-300AC

Thermometer, POCKET Digital(F)

Order Part #: P-300A



Thermostat, Defrost

Order Part #: P-12-00256-21
(Replaces Carrier #: 12-00256-21)



Transducer, W/ Harness (XTC)

Order Part #: P-12-00352-03SV
(Replaces Carrier #: 12-00352-03SV)



Transducer, W/ Harness

Order Part #: P-12-00283-00SV
(Replaces Carrier #: 12-00283-00SV)

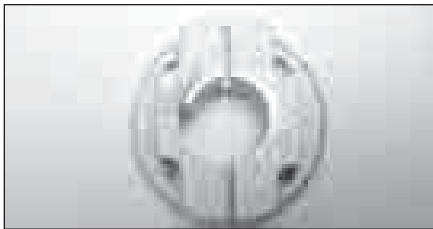

Adapter, Condenser Fan
 Order Part #: P-48-60001-00
 (Replaces Carrier #: 48-60001-00)

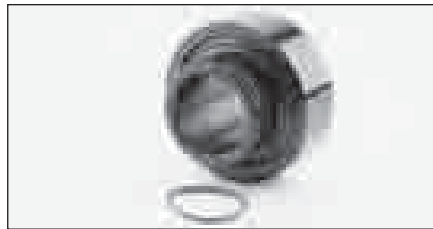

Bearing
 Order Part #: P-04-00053-00SV
 (Replaces Carrier #: 04-00053-00SV)

**ELECTRONIC
 DOOR SWITCH**

Low-profile switch
 automatically stops and
 restarts reefer when door
 is opened and closed.

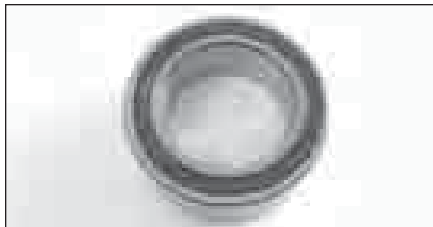

Bearing, Clutch
 Order Part #: P-50-50050-03
 (Replaces Carrier #: 50-50050-03)

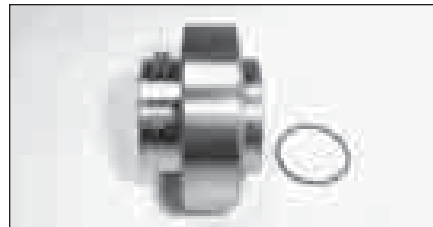

Bearing, Fan Shaft
 Order Part #: P-04-00041-00SV
 (Replaces Carrier #: 04-00041-00SV)



Bearing, Fan Shaft
 Order Part #: P-04-60008-29
 (Replaces Carrier #: 04-60008-29)

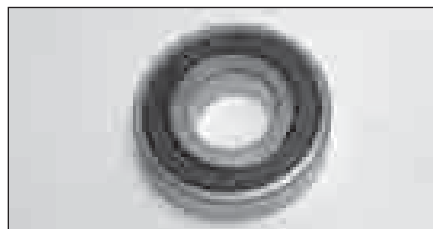

Bearing, Idler
 Order Part #: P-48-01039-23
 (Replaces Carrier #: 48-01039-23)

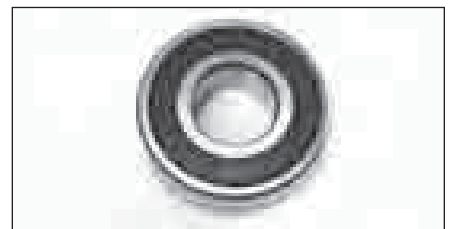

Bearing, Idler
 Order Part #: P-04-00018-00
 (Replaces Carrier #: 04-00018-00)

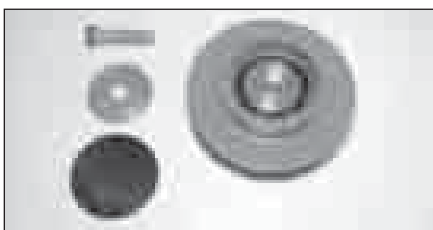

Bearing, Idler
 Order Part #: P-50-01152-25SV
 (Replaces Carrier #: 50-01152-25SV)

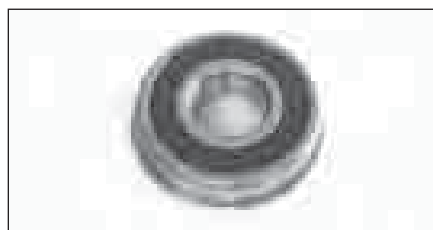

Bearing, Jackshaft
 Order Part #: P-04-00054-00
 (Replaces Carrier #: 04-00054-00)

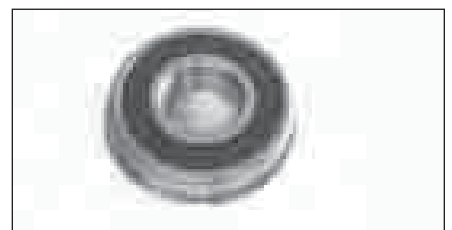

Bearing, Jackshaft
 Order Part #: P-04-50015-00
 (Replaces Carrier #: 04-50015-00)

Truck & Trailer Parts – DRIVE

MASTER BELT CROSS REFERENCE

MODEL	APPLICATION	ORDER TK NO.
Advantage	Belt, Water Pump-----	P-50-00162-04
	Belt, Drive To Jackshaft (NDJ) -----	P-50-00178-00
	Belt, Alternator To Jackshaft -----	P-50-00179-00
	Belt, Jackshaft To Fan Shaft -----	P-50-01161-02
	Belt, Jackshaft To Fan Shaft -----	P-50-00183-01
Eagle	Belt, Water Pump-----	P-50-00162-04
	Belt, Drive To Jackshaft-----	P-50-00162-05
	Belt, Clutch To Jackshaft -----	P-50-00162-06
	Belt, Jackshaft To Condenser Fan-----	P-50-01001-01
	Belt Set, Motor To Clutch -----	P-50-01101-01
EuroPhoenix	Belt, Electric Motor-----	P-50-00178-05
	Belt, Double V (Eng/Comp)-----	P-50-01166-00
Extra	Belt, Water Pump-----	P-50-00162-04
	Belt, Condenser Fan-----	P-50-00178-07
	Belt, Compressor Drive -----	P-50-00178-08
	Belt Set, Motor To Compressor -----	P-50-00178-51
	Belt, Multi Temp -----	P-50-00179-20
Extra XT	Belt, Alternator / Water Pump-----	P-50-00162-18
	Belt, Compressor Drive -----	P-50-00178-08
	Belt, Upper Drive -----	P-50-00178-24
Genesis R70	Belt Set, Engine To Compressor -----	P-50-00162-53
	Belt, Alternator-----	P-50-60006-02
	Belt, Compressor to Elec. Motor-----	P-50-60007-00
	Belt, Water Pump-----	P-50-60197-04
Genesis R90	Belt, Water Pump-----	P-25-33023-00
	Belt, Double V (Eng/Comp)-----	P-50-01166-00
	Belt, Comp to Elect Motor -----	P-50-00178-55
	Belt, Alternator/Generator -----	P-50-00179-19
Genesis TM900/1000	Belt, Water Pump-----	P-50-00162-04
	Belt, Condenser Fan-----	P-50-00178-07
	Belt, Compressor Drive -----	P-50-00178-08
	Belt, Alternator-----	P-50-00179-20
Genesis Multi-Temp TM900/1000	Belt, Water Pump (134TV) -----	P-50-00162-04
	Belt, Water Pump (134DI)-----	P-50-00162-22
	Belt, Condenser Fan S/N HAD90547903-HAY90594028 -----	P-50-00178-07
	Belt, Compressor Drive -----	P-50-00178-08
	Belt, Generator-----	P-50-00178-18
	Belt, Alternator-----	P-50-00179-20
	Belt, Generator (Multi-Temp)-----	P-50-01001-03
Genesis TR1000	Belt, Standby Motor (NDD)-----	P-50-00178-51
	Belt, Standby Motor (NDC) -----	P-50-00162-14
	Belt, Water Pump-----	P-50-00162-04
GenSet	Belt, Water Pump-----	P-50-00162-04
	Belt, Alternator-----	P-50-00204-01
Maxima	Belt Set, Motor To Compressor -----	P-50-00178-51
	Belt Set, Classical -----	P-50-00178-56
	Belt, Vent Box-----	P-50-00179-57
	Belt, Water Pump (Maxima 2)-----	P-50-60197-06

(continued)

MASTER BELT CROSS REFERENCE (continued)

MODEL	APPLICATION	ORDER TK NO.
	Belt, Clutch-----	P-50-60198-55
	Belt, Vent Box (Maxima)-----	P-50-60288-01
	Belt, Electric Motor-----	P-50-60297-00
Metrobird	Belt Set, Motor to Compressor-----	P-50-00179-51
Optima	Belt, Alternator-----	P-50-00162-08
	Belt, Water Pump-----	P-50-00162-10
	Belt, Condenser Fan-----	P-50-00178-07
	Belt, Compressor Drive-----	P-50-00178-12
Solara	Belt, Water Pump-----	P-50-00162-10
Supra 922/944 and Supra 950	Belt, Water Pump-----	P-25-33023-00
	Belt Set, Electric Motor-----	P-50-00178-58
	Belt, Double V (Eng/Comp)-----	P-50-01166-00
	Belt, Alternator-----	P-50-60006-02
	Belt, Alternator (950)-----	P-50-00179-20
Supra 844 and Supra 850	Belt Set, Engine to Compressor-----	P-50-00179-56
	Belt, Comp to Standby Motor-----	P-50-00179-54
	Belt, Water Pump-----	P-50-60197-04
	Alternator-----	P-50-60198-14
Supra 622/644 722/744	Belt Set, Engine To Compressor-----	P-50-00162-53
	Belt, Alternator-----	P-50-60006-02
	Belt, Elec. Motor To Compressor-----	P-50-60007-00
	Belt, Water Pump-----	P-50-60197-04
	Tension Support Kit, Belt-----	P-79-02322-01
Supra 650/750	Alternator/Compressor-----	P-50-00162-25
	Motor/Compressor – 230V and 460V units-----	P-50-00178-22
	Engine/Compressor-----	P-50-60198-49
	Water Pump-----	P-50-60197-04
Supra 550	Belt, Water Pump-----	P-25-34856-00
	Motor/Compressor – 230V and 460V units-----	P-50-00178-22
	Motor/Compressor – Non-standby Units-----	P-50-60289-00
	Engine/Compressor-----	P-50-60198-48
	Alternator/Compressor-----	P-50-60288-21
Supra 422	Belt, Water Pump-----	P-25-34856-00
	Belt, Alternator-----	P-50-00179-03
	Belt, Compressor To Motor-----	P-50-00179-05
	Belt, Engine To Compressor-----	P-50-60198-44
	Tension Support Kit, Belt-----	P-79-02322-01
Thunderbird	Belt, Alternator (Early Model)-----	P-50-00162-03
	Belt, Water Pump-----	P-50-00162-04
	Belt, Drive To Jackshaft (NDJ)-----	P-50-00178-00
	Belt, Drive To Jackshaft (NDF)-----	P-50-00178-01
	Belt, Alternator To Jackshaft-----	P-50-00179-00
	Belt, Condenser Fan (Early Model)-----	P-50-01001-11
	Belt Set, Motor To Clutch (NDF)-----	P-50-01101-01
	Belt, Jackshaft To Fan Shaft-----	P-50-01161-02
Ultima	Belt, Water Pump-----	P-50-00162-04
	Belt, Compressor Drive-----	P-50-00178-16
	Belt, Condenser Fan-----	P-50-00178-20
	Belt, Alternator-----	P-50-00179-22

(continued)

Truck & Trailer Parts – DRIVE

MASTER BELT CROSS REFERENCE (continued)

MODEL	APPLICATION	ORDER TK NO.
Ultima (XTC)	Belt, Alt to Water Pump-----	P-50-00162-22
	Belt, Cross Section Lower Drive -----	P-50-00178-19
	Belt, Cross Section Upper Drive -----	P-50-00178-26
Ultra	Belt, Water Pump-----	P-50-00162-04
	Belt, Alternator-----	P-50-00162-08
	Belt, Condenser Fan-----	P-50-00178-07
	Belt, Compressor Drive -----	P-50-00178-08
	Belt, Generator (Muti-Temp) -----	P-50-00178-10
	Belt, Alternator (105 Amp) -----	P-50-00178-13
	Belt, Diesel/Electric (NDM) -----	P-50-00178-23
	Belt Set, Standby Motor (NDM)-----	P-50-00178-51
	Belt, Alternator (3.5" Pulley) -----	P-50-00179-09
	Belt, Alternator (3" Pulley) -----	P-50-00179-20
	Ultra XL	Belt, Alternator to Water Pump -----
Belt, Condenser Fan-----		P-50-00178-07
Belt, Compressor Drive -----		P-50-00178-08
Belt Set, Standby Motor -----		P-50-00178-51
Belt, Alternator-----		P-50-00179-20
Ultra XT	Belt, Alternator to Water Pump -----	P-50-00162-22
	Belt, Cross Section Lower Drive -----	P-50-00178-19
	Belt, Cross Section, Upper Drive -----	P-50-00178-24
Ultra XTC	Belt, Alternator to Water Pump -----	P-50-00162-22
	Belt, Cross Section Lower Drive -----	P-50-00178-19
	Belt, Cross Section, Upper Drive-----	P-50-00178-24

OTHER BELTS ALSO AVAILABLE

CARRIER NO.	DESCRIPTION	ORDER TK NO.
50-00162-00	Belt, (GC Model)	P-50-00162-00
50-00162-02	Belt	P-50-00162-02
50-00162-07	Belt	P-50-00162-07
50-00162-20	Belt	P-50-00162-20
50-00178-04	Belt	P-50-00178-04
50-00178-14	Belt	P-50-00178-14
50-00179-52	Belt	P-50-00179-52
50-01001-00	Belt	P-50-01001-00
50-01001-15	Belt	P-50-01001-15
50-01086-06	Belt, Matched Pair	P-50-01086-06
50-01094-00	Belt	P-50-01094-00
50-01094-02	Belt	P-50-01094-02
50-01094-03	Belt	P-50-01094-03
50-60198-11	Belt	P-50-60198-11
50-01001-03	Belt	P-50-01001-03

DRIVE

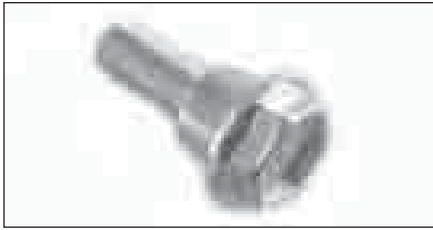

Bolt, Shoulder
 Order Part #: P-48-00058-02
 (Replaces Carrier #: 48-00058-02)

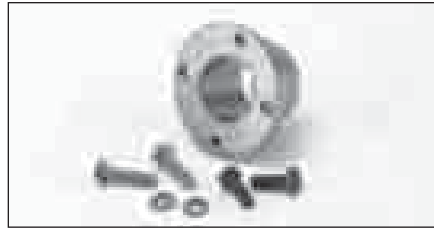

Bushing, Split Taper
 Order Part #: P-04-00122-02
 (Replaces Carrier #: 04-00122-02)

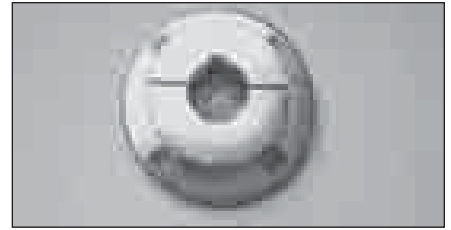

Bushing, Split Taper
 Order Part #: P-04-00122-10
 (Replaces Carrier #: 04-00122-10)



Bushing, Split Taper
 Order Part #: P-04-00122-15
 (Replaces Carrier #: 04-00122-15)

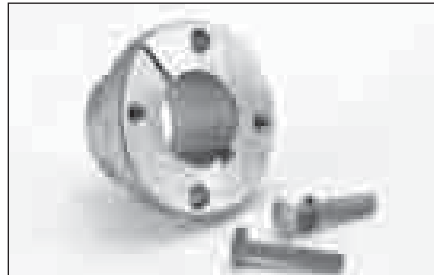

Bushing, Split Taper
 Order Part #: P-04-00122-30SVB
 (Replaces Carrier #: 04-00122-30SV)



Clutch (Ultima)
 Order Part #: P-50-00228-02SV
 (Replaces Carrier #: 50-00228-02SV)



Clutch Supra 6/7
 Order Part #: P-50-01165-01-C
 (Replaces Carrier #: 50-01165-01)



Clutch, Supra 844/422
 Order Part #: P-50-60029-00-C
 (Replaces Carrier #: 50-60029-00)



Clutch, Supra 922/944
 Order Part #: P-50-50051-04-C
 (Replaces Carrier #: 50-50051-04)



Clutch, 2/A Groove (VP Truck)
 Order Part #: P-AC501-292
 (Replaces Carrier #: AC501-292)



Clutch, 8 Groove (VP Truck)
 Order Part #: P-AC501-291
 (Replaces Carrier #: AC501-291)



Clutch, A/B Groove 12V (VP Truck)
 Order Part #: P-17-31252-00
 (Replaces Carrier #: 17-31252-00)

Truck & Trailer Parts – DRIVE



PG Specific

Coil, Clutch PG
 Order Part #: P-50-00215-25SVPG
 (Only for PG Clutch
 Assembly. P-50-00215-01SV)

**Clutch Assembly
 (For Gearbox P-50-00214-03)**
 Order Part #: P-50-00215-01SV
 (Replaces Carrier #: 50-00215-01SV)

**WORKS FOR BOTH CARRIER
 AND PG CLUTCH**



Hardware, Clutch Package
 Order Part #: P-50-00215-23
 (Replaces Carrier #: 50-00215-23)

CLUTCH TOOLS



**Socket, Wrench
 (Gearbox Clutch)**
 Order Part #: P-07-00303-01
 (Replaces Carrier #: 07-00303-01)



**Socket, Wrench
 (XTC Clutch)**
 Order Part #: P-07-00303-02
 (Replaces Carrier #: 07-00303-02)



**Wrench, Spanner
 Clutch (XTC)**
 Order Part #: P-07-00396-01
 (Replaces Carrier #: 07-00396-01)



Coil, Clutch (VP Truck)
 Order Part #: P-17-31307-00
 (Replaces Carrier #: 17-31307-00)



Clutch, XTC
 Order Part #: P-50-00236-05-B
 (Replaces Carrier #: 50-00236-05)
Shims (.01") #: P-50-00232-43
Shims (.02") #: P-50-00232-42

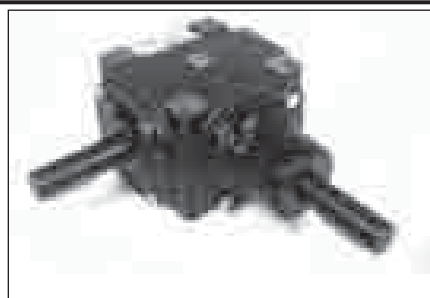

Drive Assembly, Gear Box
 Order Part #: P-50-00227-01
 (Replaces Carrier #: 50-00227-01)

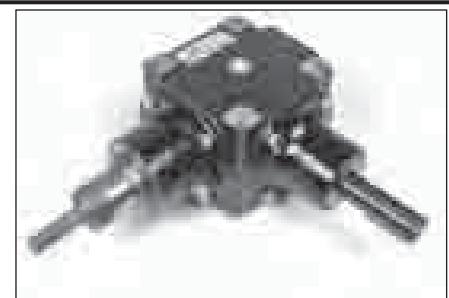

Drive Assembly, Gear Box
 Order Part #: P-50-00214-03
 (Replaces Carrier #: 50-00214-03)

PG PARTS GEAR BOXES BENEFITS:

- Spiral cut gears (vs. straight cut) to offer higher HP and RPM capacity and reduces 'foaming'
- Tapered roller bearings (vs. ball) for better shaft support and gear life
- Viton seals (vs. Nitrile) for longer seal life
- High temperature synthetic oil to reduce 'foaming'
- No venting needed

**Carrier Gear Box
Parts**

Use Only With
Carrier Gear Boxes

Note:

Not For Use on PG Gear Box
P-50-00214-03
or P-50-00227-01

Shim (0.002) (9/Pk)

Order Part #: P-50-00214-24
(Replaces Carrier #: 50-00214-24)

Shim (0.005) (9/Pk)

Order Part #: P-50-00214-23
(Replaces Carrier #: 50-00214-23)

Bearing, Ball (Drive Gear)

Order Part #: P-50-00214-31
(Replaces Carrier #: 50-00214-31)

Bearing, Ball (Drive Gear)

Order Part #: P-50-00214-32
(Replaces Carrier #: 50-00214-32)

Kit Shaft, Seal (Key Incl.)

Order Part #: P-50-00214-55SV
(Replaces Carrier #: 50-00214-55SV)

**Kit Shaft, Seal
(Shaft & Dust Seals)**

Order Part #: P-50-50057-00
(Replaces Carrier #: 50-50057-00)

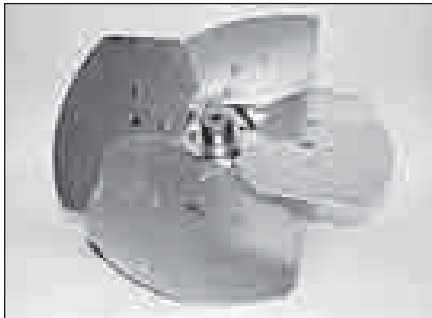

Fan

Order Part #: P-38-60018-00
(Replaces Carrier #: 38-60018-00)



Fan, Condenser

Order Part #: P-38-00550-00
(Replaces Carrier #: 38-00550-00)



Fan, Condenser

Order Part #: P-38-60000-01
(Replaces Carrier #: 38-60000-01)

PG Parts Condenser

Fan Kit Benefits:

- Unique airfoil profile blade for greater efficiencies and lower noise
- Corrosion-resistant materials
- Lightweight
- Uses individual blades that can be easily replaced

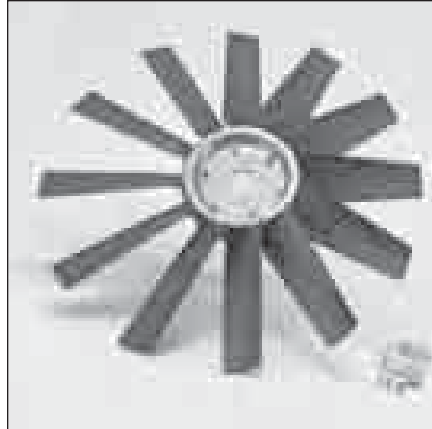

Fan, Condenser

Order Part #: P-38-00528-00SV
(Replaces Carrier #: 38-00528-00SV)



Fan, Evap

Order Part #: P-38-60009-00
(Replaces Carrier #: 38-60009-00)

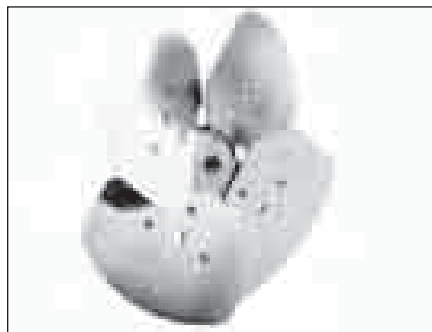

Fan, Evaporator

Order Part #: P-38-60010-00
(Replaces Carrier #: 38-60010-00)



Gear Package

Order Part #: P-48-50005-00-B
(Replaces Carrier #: 48-50005-00)

Truck & Trailer Parts – DRIVE

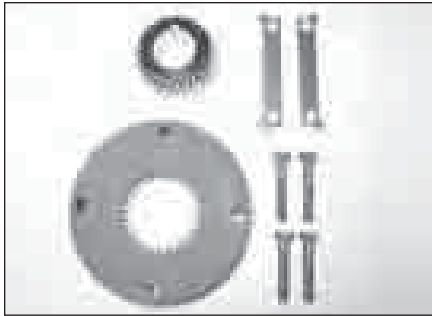

Gear Package, U-Drive

Order Part #: P-48-50003-00-B
(Replaces Carrier #: 48-50003-00)

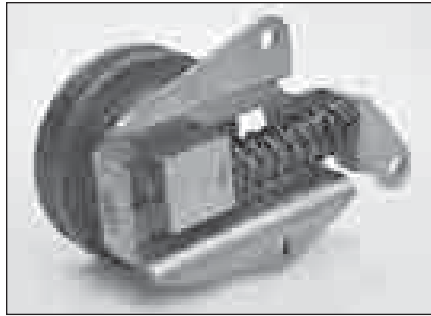

Idler Assy

Order Part #: P-25-34424-00
(Replaces Carrier #: 25-34424-00)



Idler Assy

Order Part #: P-50-01152-00
(Replaces Carrier #: 50-01152-00)

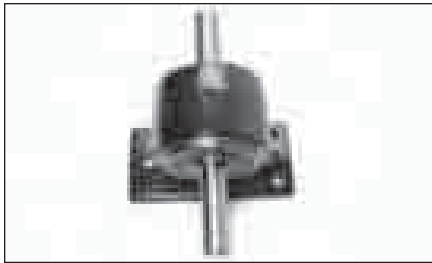

Jackshaft

Order Part #: P-79-01472-00
(Replaces Carrier #: 79-01472-00)



Key, Fanshaft 1/4"

Order Part #: P-50-00229-24
(Replaces Carrier #: 50-00229-24)

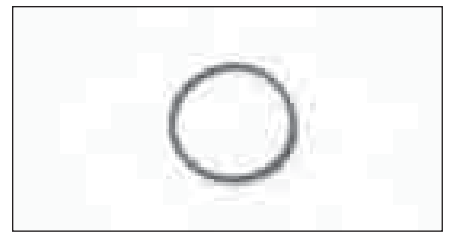

O-Ring, Fan Shaft Housing

Order Part #: P-42-01134-00
(Replaces Carrier #: 42-01134-00)



Pulley Assembly, Idler Tensioner

Order Part #: P-25-15450-00
(Replaces Carrier #: 25-15450-00)



Pulley Assy, Idler

Order Part #: P-50-60021-00
(Replaces Carrier #: 50-60021-00)



Pulley Assy, Water Pump Idler

Order Part #: P-48-00058-01
(Replaces Carrier #: 48-00058-01)

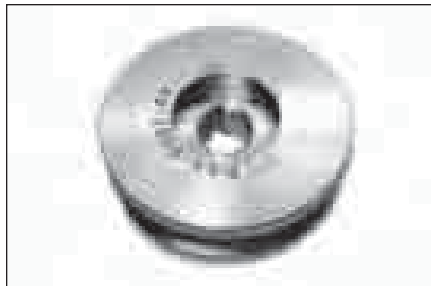

Pulley, Alternator

Order Part #: P-50-01127-03
(Replaces Carrier #: 50-01127-03)

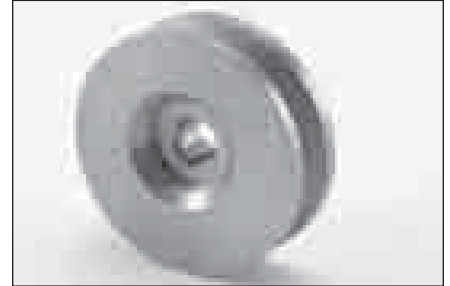

Pulley, Alternator

Order Part #: P-50-01127-12
(Replaces Carrier #: 50-01127-12)



Pulley, Idler Assembly
 Order Part #: P-50-60005-00
 (Replaces Carrier #: 50-60005-00)

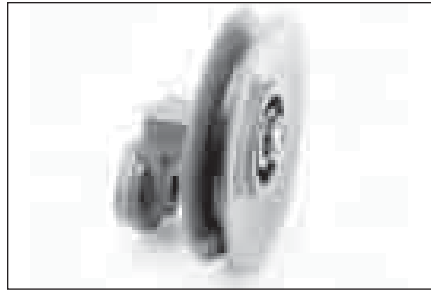

Pulley, Idler
 Order Part #: P-48-00058-28
 (Replaces Carrier #: 48-00058-28)

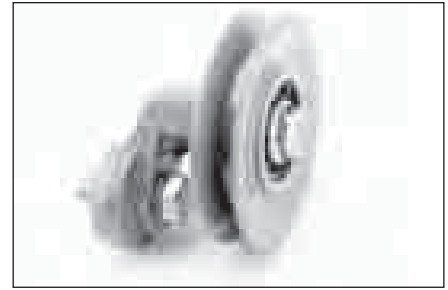

Pulley, Idler
 Order Part #: P-48-00058-29
 (Replaces Carrier #: 48-00058-29)

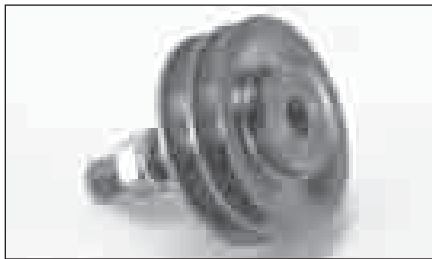

Pulley, Idler
 Order Part #: P-50-60156-01
 (Replaces Carrier #: 50-60156-01)



Pulley, Idler
 Order Part #: P-50-01152-20SV
 (Replaces Carrier #: 50-01152-20SV)

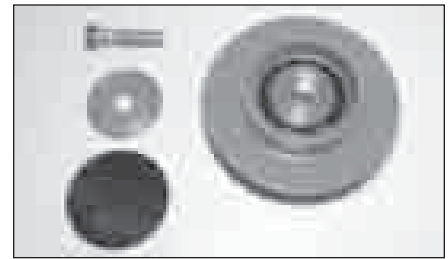

Pulley, Idler
 Order Part #: P-50-01152-22SV
 (Replaces Carrier #: 50-01152-22SV)

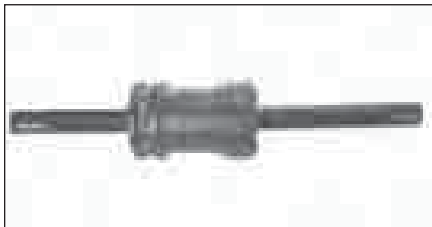

Shaft Assembly, Fan (Advantage/Thunderbird)
 Order Part #: P-50-01150-01SV
 (Replaces Carrier #: 50-01150-01SV)

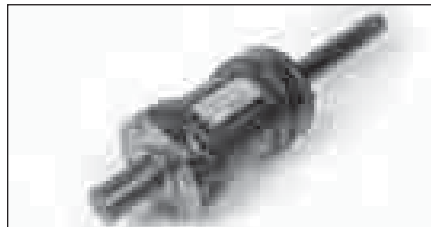

Shaft Assembly, Fan (Ultra/Extra)
 Order Part #: P-50-01148-01SV
 (Replaces Carrier #: 50-01148-01SV)

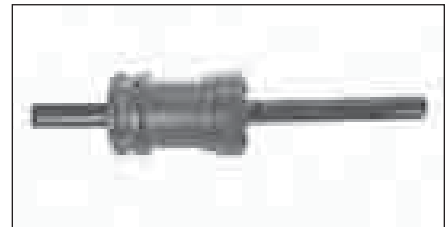

Shaft, Fan (Ultima)
 Order Part #: P-50-00229-00SV
 (Replaces Carrier #: 50-00229-00SV)

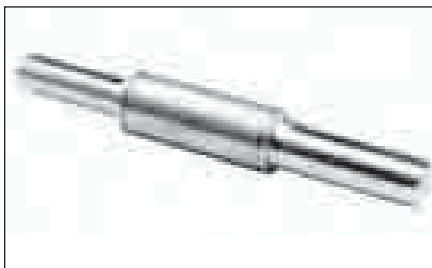

Shaft, Fan (Advantage)
 Order Part #: P-48-00178-00
 (Replaces Carrier #: 48-00178-00)

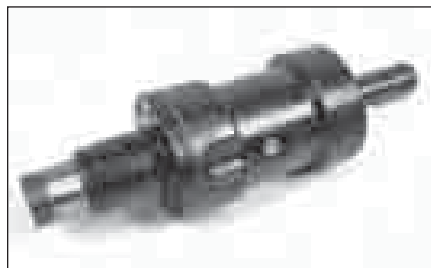

Shaft, Fan (XTC)
 Order Part #: P-50-00232-09SV
 (Replaces Carrier #: 50-00232-09SV)
Also Available: Key, Fan Shaft
 Order Part #: P-50-00232-24



Spacer, Pulley
 Order Part #: P-48-00058-05
 (Replaces Carrier #: 48-00058-05)

For your Thermo King Units

Remote Status Lights



Stay on top of your reefer's status with just a glance in the rear view mirror!

- Available in 3 configurations
- Helps avoid expensive out-of-fuel shutdowns
- For use with all Thermo King SB trailer units with SR-2 controllers (basic Status Light works with any controller)
- Solid state design - sealed against elements with no bulbs to replace

**AVAILABLE FOR
CARRIER UNITS! SEE
PAGE 65**

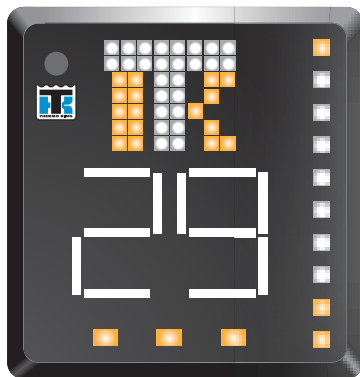

Triple Combo Display

With all of the features of the Status Only and Fuel Combo Displays, this Display also gives you the reefer temperature.

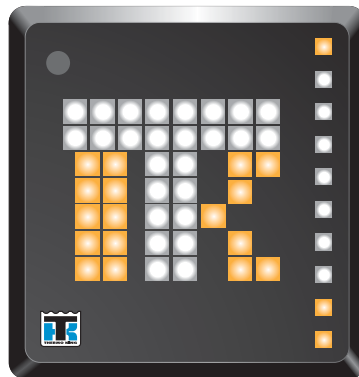

Fuel Combo Display

Offers all features of Status Only display, plus fuel level display and low fuel, check alarm and shutdown alarms.



Status Only Display

Provides on-road visibility to basic functions, including check alarm codes and shutdown alarms.

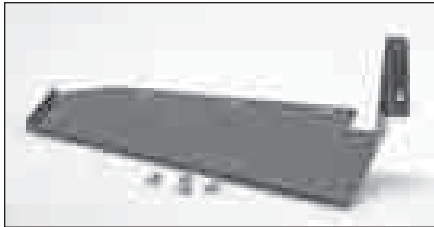

Belt Guard (Ultra)

Order Part #: P-79-02316-03
(Replaces Carrier #: 79-02316-03)

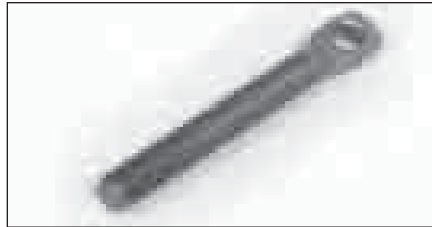

Bolt

Order Part #: 55-2762
(Replaces Carrier #: 34-50009-00)

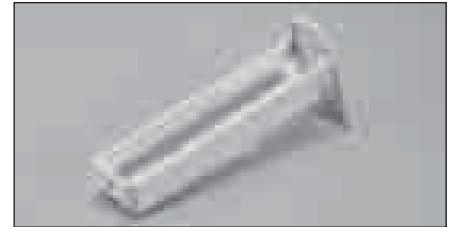

Bracket Assembly, Idler

Order Part #: P-86-02877-00
(Replaces Carrier #: 86-02877-00)



Bracket, Alternator

Order Part #: P-68-07330-00
(Replaces Carrier #: 68-07330-00)



Bracket, Alternator

Order Part #: P-86-60372-03
(Replaces Carrier #: 86-60372-03)



Bracket, Idler Assembly

Order Part #: P-79-02322-00
(Replaces Carrier #: 79-02322-00)



Bracket, J-Bolt

Order Part #: P-68-11089-00
(Replaces Carrier #: 68-11089-00)



Bracket, Tension

Order Part #: P-68-07514-01
(Replaces Carrier #: 68-07514-01)

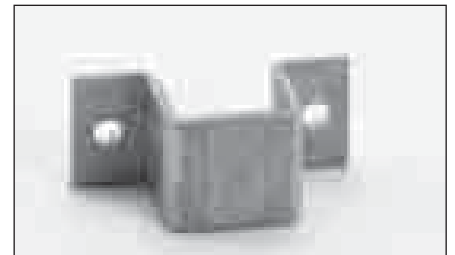

Bracket, Thermo Switch

Order Part #: P-68-60065-00
(Replaces Carrier #: 68-60065-00)



Bushing, 1/4"

Order Part #: P-40-00121-01
(Replaces Carrier #: 40-00121-01)

Truck & Trailer Parts – STRUCTURAL

STRUCTURAL

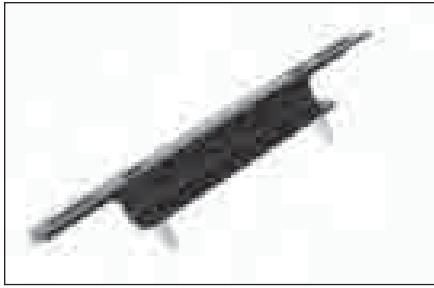

Channel, Battery Hold Down

Order Part #: P-68-07371-00SV
(Replaces Carrier #: 68-07371-00SV)

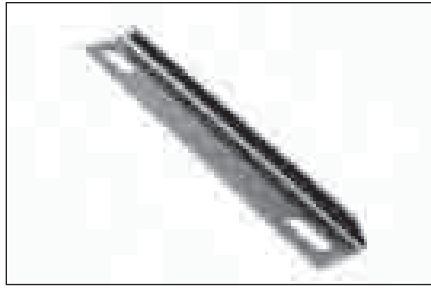

Channel, Battery Hold Down

Order Part #: P-68-11596-00
(Replaces Carrier #: 68-11596-00)

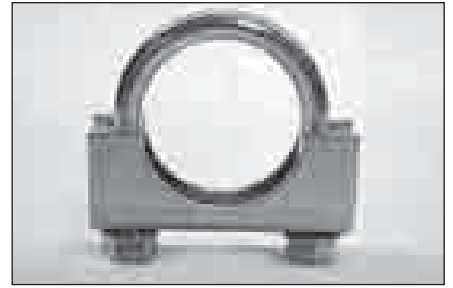

Clamp, U-Bolt 1.5

Order Part #: P-30-01052-03
(Replaces Carrier #: 30-01052-03)

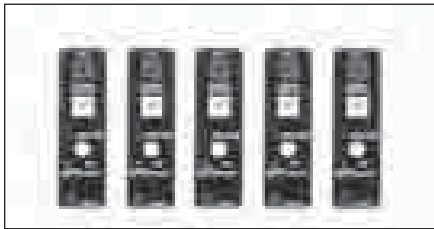

Decal, Switch

Order Part #: P-62-02448-00
(Replaces Carrier #: 62-02448-00)

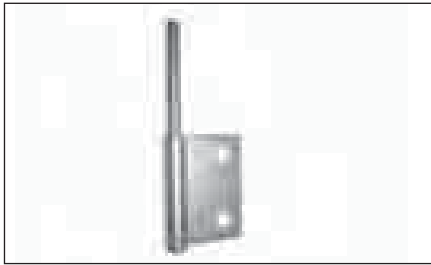

Hinge

Order Part #: P-44-00236-03
(Replaces Carrier #: 44-00236-03)



Hinge, Assembly

Order Part #: P-44-00358-00
(Replaces Carrier #: 44-00358-00)

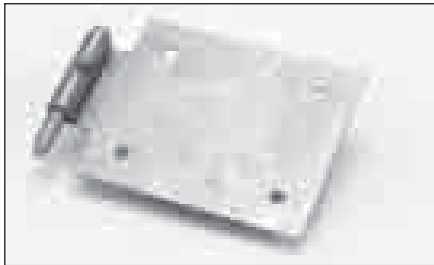

Hinge, Pin CS

Order Part #: P-44-01152-01
(Replaces Carrier #: 44-01152-01)

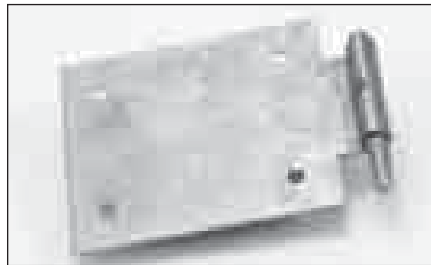

Hinge, Pin RS

Order Part #: P-44-01152-00
(Replaces Carrier #: 44-01152-00)



Hinge, Pin

Order Part #: P-44-00322-01
(Replaces Carrier #: 44-00322-01)

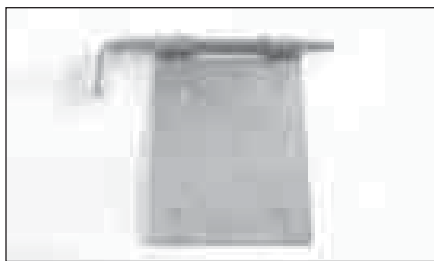

Hinge, Release (Pull Pin) Curbside

Order Part #: P-44-00320-01
(Replaces Carrier #: 44-00320-01)

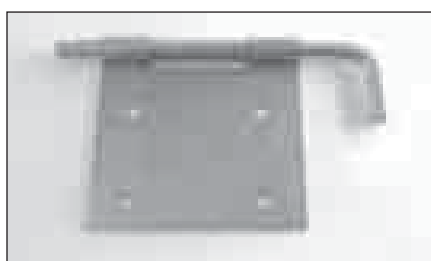

Hinge, Release (Pull Pin) Curbside

Order Part #: P-44-00323-01
(Replaces Carrier #: 44-00323-01)

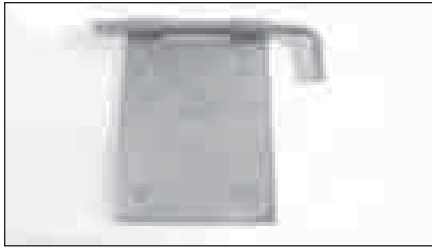

Hinge, Release (Pull Pin) Roadside

Order Part #: P-44-00320-00
(Replaces Carrier #: 44-00320-00)

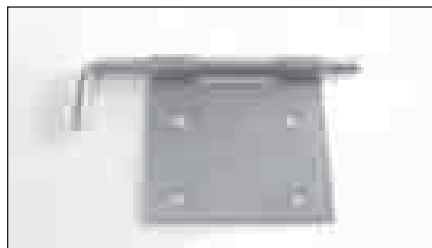

Hinge, Release (Pull Pin) Roadside

Order Part #: P-44-00323-00
(Replaces Carrier #: 44-00323-00)



Hinge, Slip

Order Part #: P-44-00410-00
(Replaces Carrier #: 44-00410-00)



Hinge, Slip F, Road & Curb

Order Part #: P-44-00236-02
(Replaces Carrier #: 44-00236-02)

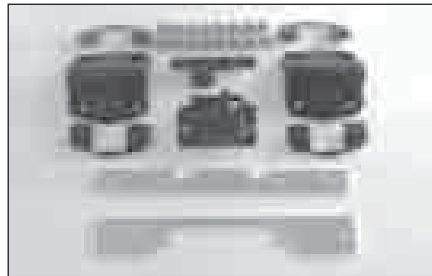

Hinge Micro Door Kit

Order Part #: P-76-00523-02
(Replaces Carrier #: 76-00523-02)



Hinge Kit, Front Door

Order Part #: P-76-00570-00
(Replaces Carrier #: 76-00570-00)

– ALSO AVAILABLE –

Hinge Kit, Side Door

Order Part #: P-76-00532-00SV
(Replaces Carrier #: 76-00532-00SV)



Hold Down, Battery

Order Part #: P-86-01867-00
(Replaces Carrier #: 86-01867-00)



J-Bolt, Battery Hold Down

Order Part #: P-34-00955-05
(Replaces Carrier #: 34-00955-05)

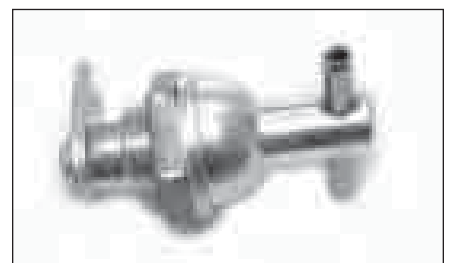

Latch

Order Part #: P-44-01133-00
(Replaces Carrier #: 44-01133-00)



J-Latch Assy Kit

Order Part #: P-76-50055-03
(Replaces Carrier #: 76-50055-03)

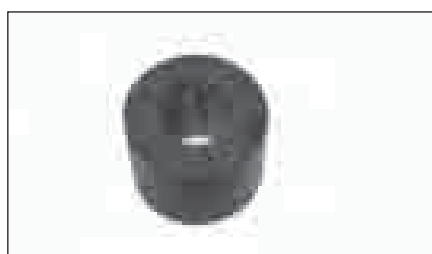

Bushing, Latch

Order Part #: P-44-01149-05
(Replaces Carrier #: 44-01149-05)

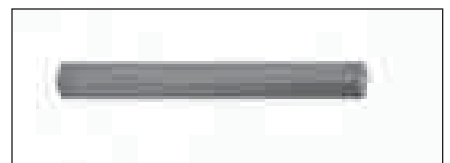

Key (1/4" Square)

Order Part #: P-34-01110-00
(Replaces Carrier #: 34-01110-00)

Truck & Trailer Parts – STRUCTURAL

STRUCTURAL

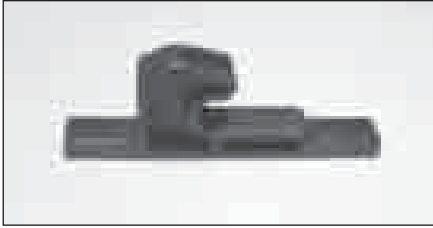

Keeper, Latch

Order Part #: P-44-00340-03
(Replaces Carrier #: 44-00340-03)

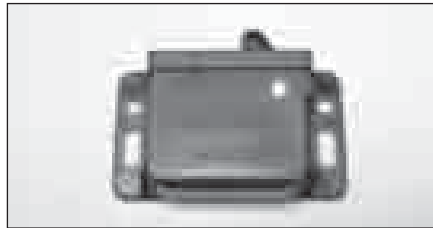

Catch, Latch

Order Part #: P-44-00340-05
(Replaces Carrier #: 44-00340-05)

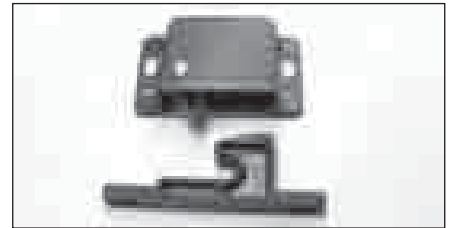

Latch Kit

Order Part #: P-44-00340-04
(Replaces Carrier #: 44-00340-04)

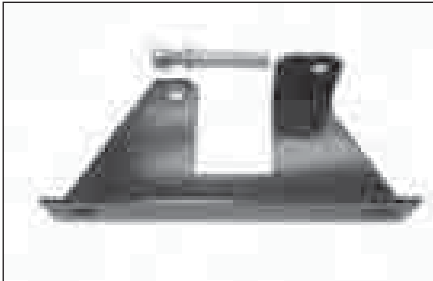

Latch Pin Bracket Kit

Order Part #: P-68-07409-00SV
(Replaces Carrier #: 68-07409-00SV)

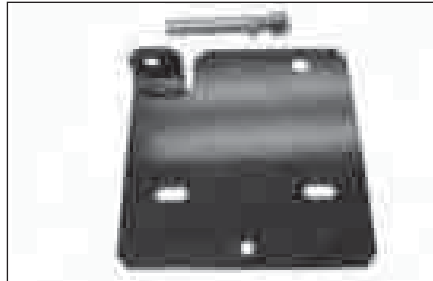

Latch Pin Bracket Kit

Order Part #: P-68-07410-00SV
(Replaces Carrier #: 68-07410-00SV)



Nut, Jam (Brass)

Order Part #: P-34-00932-13
(Replaces Carrier #: 34-00932-13)

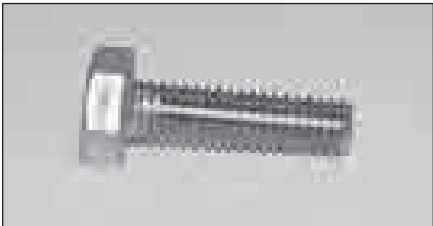

Screw

Order Part #: P-34-01152-20
(Replaces Carrier #: 34-01152-20)

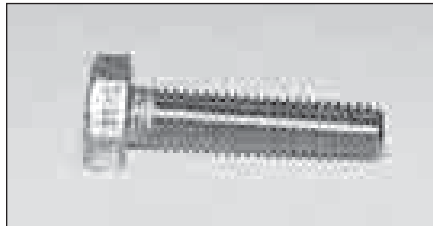

Screw

Order Part #: P-34-01152-25
(Replaces Carrier #: 34-01152-25)



Screw, Thumb (Panel)

Order Part #: P-34-06127-00
(Replaces Carrier #: 34-06127-00)



Panel, RS (Supra)

Order Part #: P-58-60012-01
(Replaces Carrier #: 58-60012-01)



Pin, Door

Order Part #: P-44-01150-00SV
(Replaces Carrier #: 44-01150-00SV)

FIBERGLASS BODY PANELS FOR EXTRA, OPTIMA, ULTIMA & ULTRA UNITS

– PANELS ARE ALL WHITE, NO TRIM COLORS –

1. Door, Side Curbside
Order Part #: P-58-01358-02W
(Replaces Carrier #: 58-01358-02)

2. Door, Front Curbside
Order Part #: P-58-01302-34W
(Replaces Carrier #: 58-01302-34)

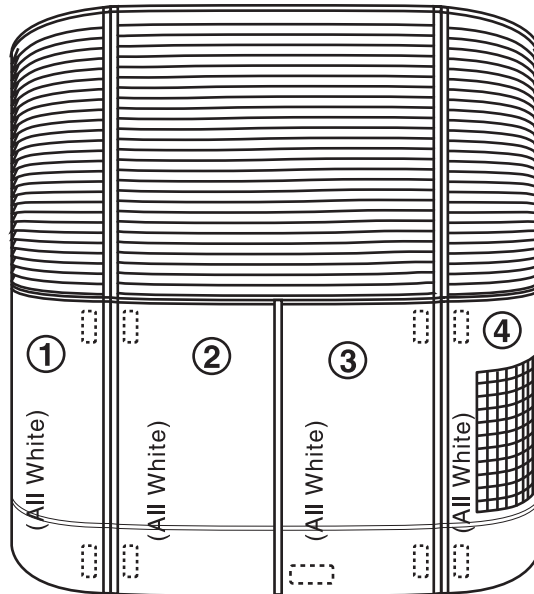

3. Door, Front Roadside
Order Part #: P-58-01301-34W
(Replaces Carrier #: 58-01301-34)

Door, Side Roadside
4. Order Part #: P-58-01314-12W
(Replaces Carrier #: 58-01314-12)

ASK US ABOUT THESE AND OTHER GENUINE THERMO KING ACCESSORIES

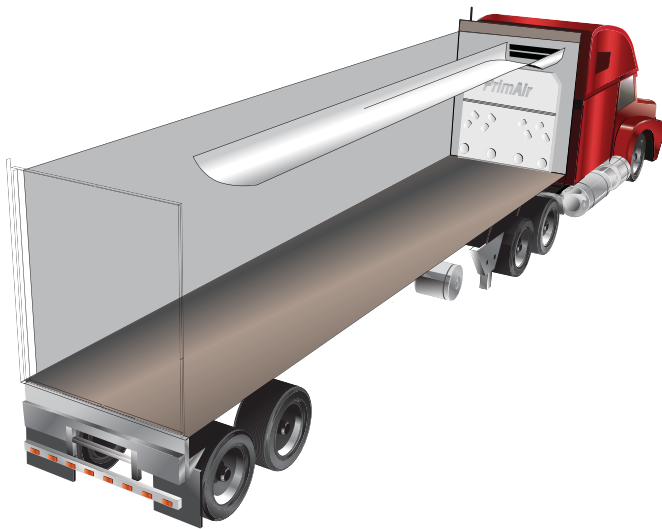

PrimAir Chute Systems for Carrier X-Series

Adapters come standard with Velcro attachment to the chute to reduce damage and be disconnected quickly for dry loads where maximum volume is required

PrimAir premium vinyl chutes have industry-leading tear strength and material tensile strength for increased life and durability

43 ft. Vinyl Air Chute	201-3030
38 ft. Vinyl Air Chute	201-3022
43 ft. PE Air Chute	201-3034
38 ft. PE Air Chute	201-3035
43 ft. Vinyl Air Chute with Rivets.....	201-3037
38 ft. Vinyl Air Chute with Rivets.....	201-3029
43 ft. PE Air Chute with Rivets	201-3040
38 ft. PE Air Chute with Rivets	201-3041

Adapter Bracket Carrier X units 201-3039

Truck & Trailer Parts – STRUCTURAL

STRUCTURAL

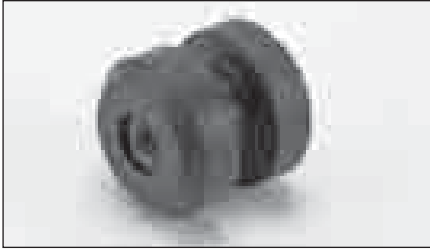

Shockmount

Order Part #: P-73-00160-02
(Replaces Carrier #: 73-00160-02)



Shockmount

Order Part #: P-73-00154-03
(Replaces Carrier #: 73-00154-03)



Shockmount

Order Part #: P-73-00096-00
(Replaces Carrier #: 73-00096-00)

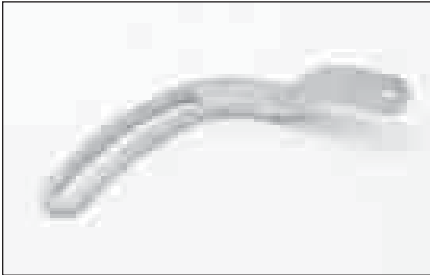

Strap, Adjusting

Order Part #: P-68-60041-01
(Replaces Carrier #: 68-60041-01)



Strap, Alternator

Order Part #: P-68-07438-03
(Replaces Carrier #: 68-07438-03)

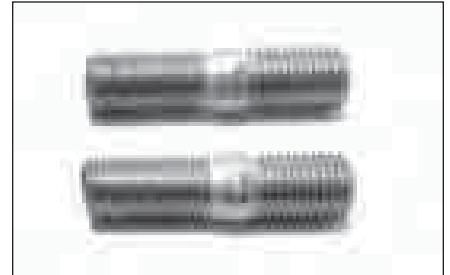

Stud (Special)

Order Part #: P-34-00964-00
(Replaces Carrier #: 34-00964-00)



Tension Support Kit, Belt

Order Part #: P-79-02322-01
(Replaces Carrier #: 79-02322-01)



Washer

Order Part #: P-34-00890-00
(Replaces Carrier #: 34-00890-00)

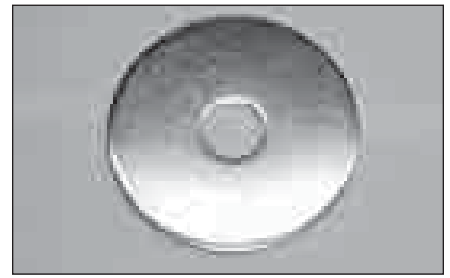

Washer

Order Part #: P-34-00890-07
(Replaces Carrier #: 34-00890-07)

BUS COMPRESSORS

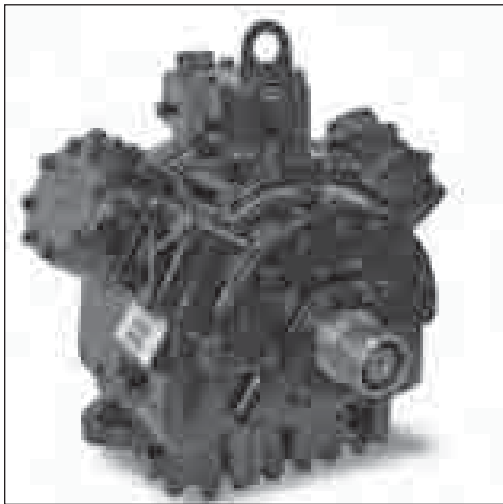

We replace the following parts with new components:

- | | |
|------------------|----------------|
| ✓ Valve | ✓ Valve plates |
| ✓ All gaskets | ✓ Bearings |
| ✓ Oil Pump | ✓ Shaft seal |
| ✓ Thrust Washers | ✓ Pistons |
| ✓ Rods | ✓ Crankshaft* |

* Replaced as new or remanufactured to OEM specification when necessary

Compressor, Reman. (05G 37 CFM) Bus

Order Part #: P-17-44065-00
(Replaces Carrier #: 17-44065-00)

Compressor, Reman. (05G 41 CFM) Bus

Order Part #: P-17-44062-00
(Replaces Carrier #: 17-44062-00)

BUS CLUTCHES



Clutch Assembly 2B, 24V

Order Part #: P-50-01122-07
(Replaces Carrier #: 50-01122-07)

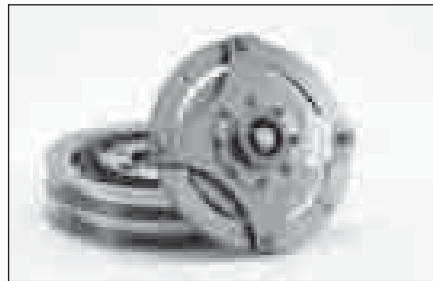

Clutch Assembly 2C, 24V

Order Part #: P-50-01122-01
(Replaces Carrier #: 50-01122-01)

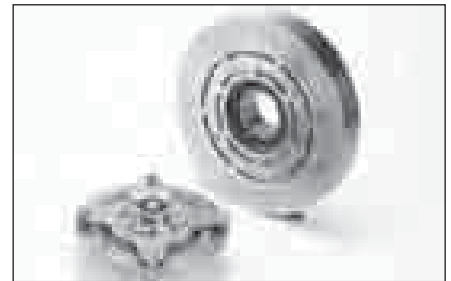

Clutch Assembly

Order Part #: P-50-01122-14
(Replaces Carrier #: 50-01122-14)



Hub, Clutch

Order Part #: P-17-44041-01
(Replaces Carrier #: 17-44041-01)

Also Available

Hub, Nut w/out grease port

Order Part #: P-34-06083-00
(Replaces Carrier #: 06083-00)

Thermo King remanufactures the Carrier® 05G bus compressors (37 and 41 CFM) to the same standard of excellence as all Thermo King compressors.

- Crankshaft remanufactured or replaced to meet original OEM specifications
- Metal gaskets (versus fiber) for the heads and unloaders
- Oil pump replaced with a new pump
- Valve plates replaced with new valves to assure proper performance
- Connecting rods/pistons/rings replaced with new components
- All components are approved by Thermo King engineers
- Two year warranty from installation date

BUS Parts – Mini-Bus/Transit/Coach

BUS FANS/BLOWERS/MOTORS

*Fits Carrier OEM Fan
(AC401-110) Only*

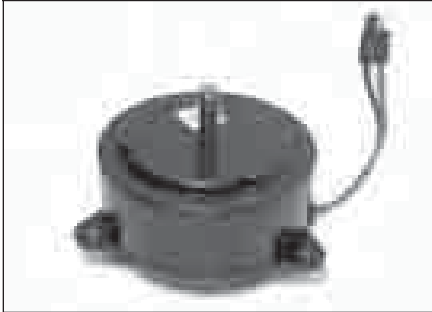

Motor, Fan 12V
Order Part #: P-AC401-110-M
(Replaces Carrier #: AC401-110-M)

*More Airflow, More Durable
Than Carrier OEM!*

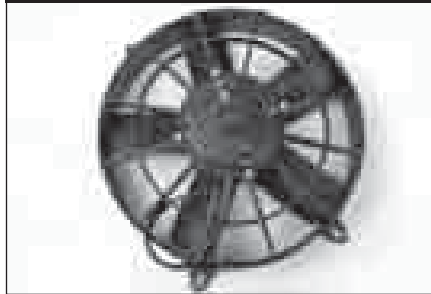

Motor/Fan, Condenser 12V
Order Part #: P-AC401-110

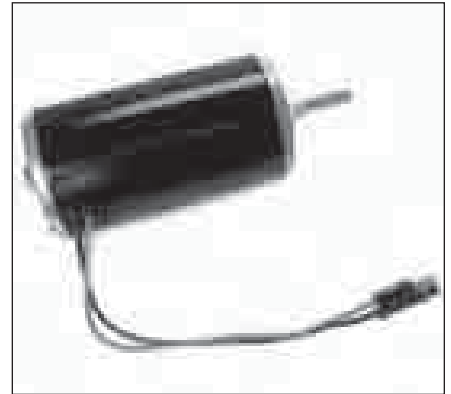

Motor, 12V Condenser
Order Part #: P-AC501-102A
(Replaces Carrier #: AC501-102A)

BUS FILTERS



Drier, Filter
Order Part #: P-14-00320-00
(Replaces Carrier #: 14-00320-00)

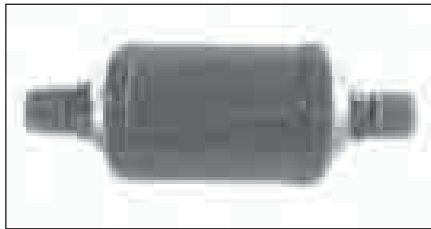

Drier, Filter
Order Part #: P-AC101-312
(Replaces Carrier #: AC101-312)



Drier
Order Part #: P-14-00288-00
(Replaces Carrier #: 14-00288-00)

BUS GASKETS/O-RINGS



**Gasket, Service Valve
(Discharge) Fiber**
Order Part #: P-17-44138-00
(Replaces Carrier #: 17-44138-00)

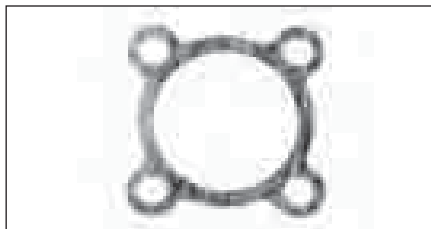

**Gasket, Service Valve
(Suction)**
Order Part #: P-17-40005-05
(Replaces Carrier #: 17-40005-05)

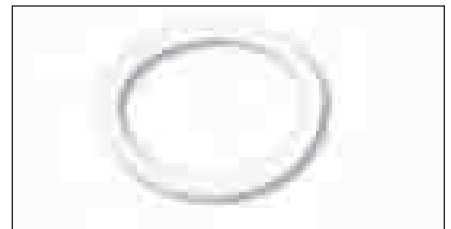

Gasket, Sight Glass
Order Part #: P-17-10218-02
(Replaces Carrier #: 17-10218-02)

BUS SWITCHES/SENSORS

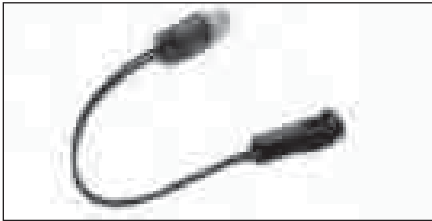

Switch, Pressure

Order Part #: P-12-00299-00
(Replaces Carrier #: 12-00299-00)



Switch, Pressure

Order Part #: P-12-00334-01
(Replaces Carrier #: 12-00334-01)

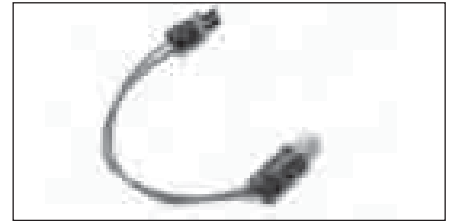

Switch, Pressure (3-9)

Order Part #: P-12-00299-01
(Replaces Carrier #: 12-00299-01)



Switch, Pressure #2, R22

Order Part #: P-12-00334-00
(Replaces Carrier #: 12-00334-00)

BUS REFRIGERATION SYSTEM



Bearing, Shaft End (Unmachined)

Order Part #: P-17-44015-00
(Replaces Carrier #: 17-44015-00)

(Machined)

Order Part #: P-17-44015-MA

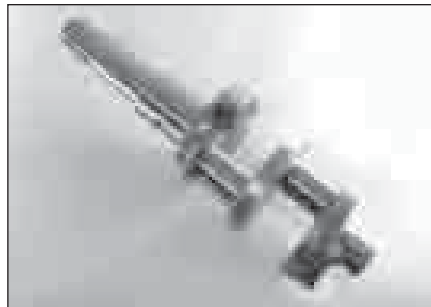

**Crankshaft (05G 37 CFM)
(All Gear Pumps)**

Order Part #: P-17-40410-00
(Replaces Carrier #: 17-40410-00)



**Crankshaft (05G 41CFM)
(All Gear Pumps)**

Order Part #: P-17-40412-00
(Replaces Carrier #: 17-40412-000)



**Crankshaft (05G 37 CFM)
(Vane Pumps Only)**

Order Part #: P-17-44010-00
(Replaces Carrier #: 17-44010-00)



Cap, Service Valve

Order Part #: P-17-10812-00
(Replaces Carrier #: 17-10812-00)

BUS Parts – Mini-Bus/Transit/Coach

BUS REFRIGERATION PARTS (continued)



Indicator, Sightglass

Order Part #: P-14-00220-00
(Replaces Carrier #: 14-00220-00)

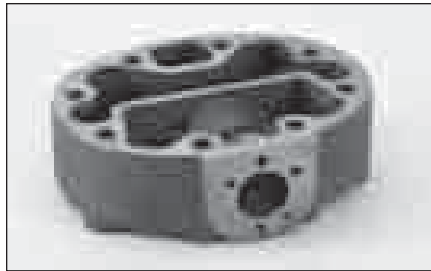

Head, Cylinder (05G) HGBP Unloader

Order Part #: P-17-40104-05
(Replaces Carrier #: 17-40104-05)

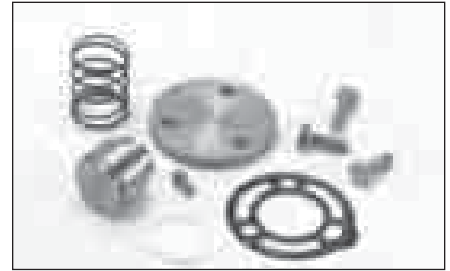

Plug Kit

Order Part #: P-17-55013-00
(Replaces Carrier #: 17-55013-00)



Pump, Oil (Universal Gear)

Order Part #: P-17-44137-00
(Replaces Carrier #: 17-44137-00)

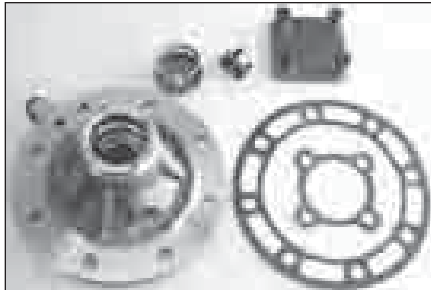

Pump, Oil (Vane)

Order Part #: P-17-40200-02
(Replaces Carrier #: 17-40200-02)



Piston, Flat Top 41 CFM

Order Part #: P-17-44121-01
(Replaces Carrier #: 17-44121-01)



Piston, Flat (Std) 37 CFM

Order Part #: P-17-44045-01
(Replaces Carrier #: 17-44045-01)

Piston, Flat (+.020") 37 CFM

Order Part #: P-17-44045-03
(Replaces Carrier #: 17-44045-03)

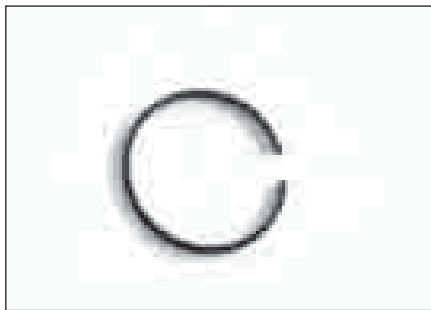

Ring, Piston (Std)

Order Part #: P-17-40055-00
(Replaces Carrier #: 17-40055-00)

Ring, Piston (+.020")

Order Part #: P-17-55025-00
(Replaces Carrier #: 17-55025-00)



Rod, Connecting (Std)

Order Part #: P-17-40056-02
(Replaces Carrier #: 17-40056-02)

Rod, Connecting (+.010")

Order Part #: P-17-55023-00
(Replaces Carrier #: 17-55023-00)

Rod, Connecting (+.020")

Order Part #: P-17-ROD020-05G

BUS Parts – Mini-Bus/Transit/Coach

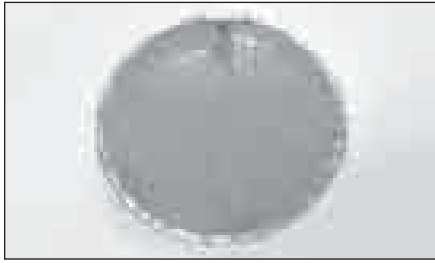

Screen, Oil Filter (05G)
Order Part #: P-17-40020-00
(Replaces Carrier #: 17-40020-00)

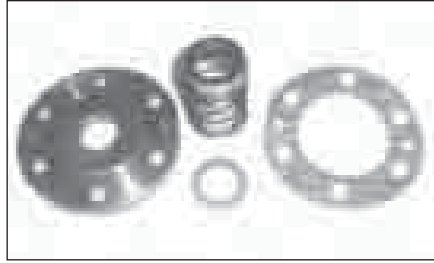

Seal, Compressor (5F30 Bus)
Order Part #: P-17-10302-00
(Replaces Carrier #: 17-10302-00)

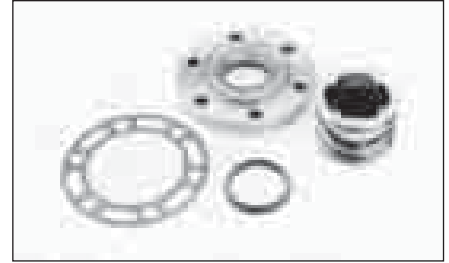

Seal, Shaft (05G)
Order Part #: P-17-44145-00
(Replaces Carrier #: 17-44145-00)



Sightglass
Order Part #: P-17-10218-00
(Replaces Carrier #: 17-10218-00)

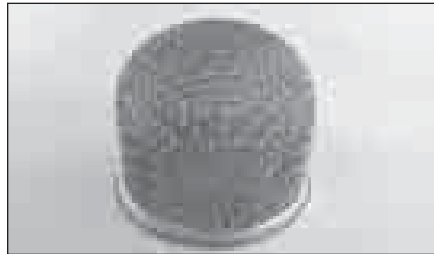

Strainer, Suction (05G)
Order Part #: P-17-44005-00
(Replaces Carrier #: 17-44005-00)

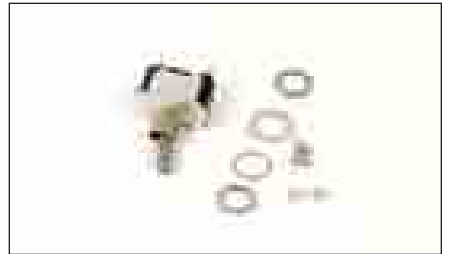

Switch, Toggle
Order Part #: P-10-00027-01
(Replaces Carrier #: 10-00027-01)



Valve, Check
Order Part #: P-14-00029-07
(Replaces Carrier #: 14-00029-07)



Valve, Relief (450 psig)
Order Part #: P-EB-51RP-061
(Replaces Carrier #: EB-51RP-061)

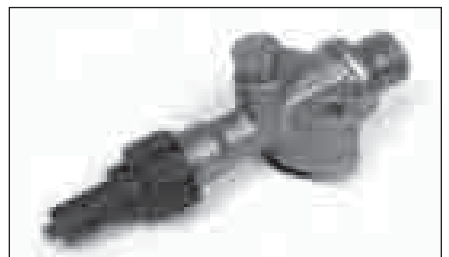

Valve, Service 7/8
Order Part #: P-14-01042-04
(Replaces Carrier #: 14-01042-04)

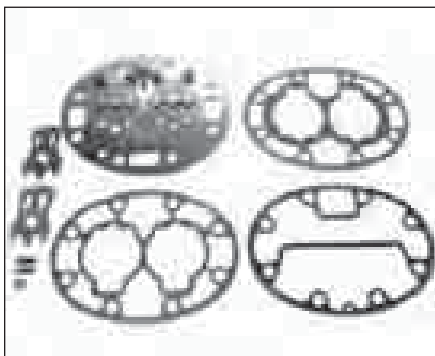

Valve Plate (Flat, Side Bank w/HGBP)
Order Part #: P-17-44106-00
(Replaces Carrier #: 17-44106-00)

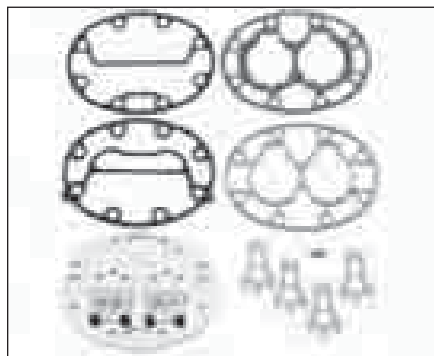

Valve Plate (Flat, Ctr or Side w/Suc.cutoff)
Order Part #: P-17-44107-00
(Replaces Carrier #: 17-44107-00)

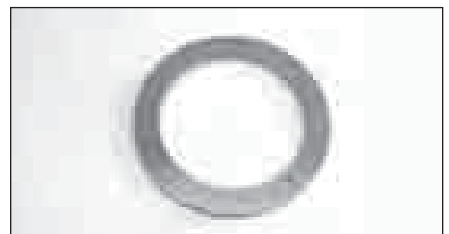

Washer, Thrust (Seal End)
Order Part #: P-17-44008-00
(Replaces Carrier #: 17-44008-00)

RELIAMAX BATTERIES

Maximum reliability for your operating conditions.

Reliable power.

Long life.

THERMO KING RELIAMAX BATTERIES.

**Choose the battery your
operating conditions demand.**

Thermo King's heavy duty ReliaMax batteries provide reliable cranking power in even the harshest conditions. Because battery life is directly related to environmental temperature, it's essential to choose the correct battery for your operating conditions to maximize battery life. Lower cold cranking amp (CCA) batteries will outlast higher CCA batteries in the same operating conditions, so choose only the CCA necessary. Thermo King offers ReliaMax batteries in 750 and 925 CCA.



ReliaMax Battery Performance

Part Number	Cold Cranking Amps	Reserve Capacity @25 AMPS (minutes)	Weight (lbs.)
925N Cold - Warm			
203-732 Post (203-736 Canada)	925	180	60
203-733 Stud (203-737 Canada)	925	180	60
750S Warm - Hot			
203-730 Post (203-734 Canada)	750	180	59
203-731 Stud (203-735 Canada)	750	180	59

CONTAINER COMPRESSOR PARTS



Bearing, Shaft End (Unmachined)
 Order Part #: P-17-44015-00
 (Replaces Carrier #: 17-44015-00)
(Machined)
 Order Part #: P-17-44015-MA

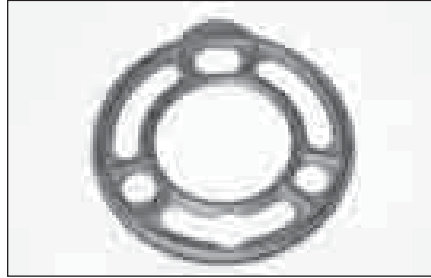

Gasket, Unloader
 Order Part #: P-17-40104-07
 (Replaces Carrier #: 17-40104-07)

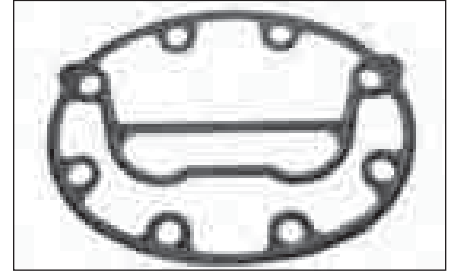

Gasket, Suction Cutout Unloader Head
 Order Part #: P-17-44125-00
 (Replaces Carrier #: 17-44125-00)

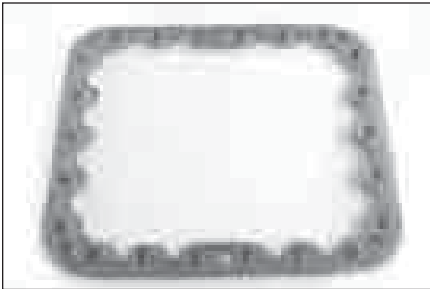

Gasket, Bottom Plate
 Order Part #: P-17-40033-05
 (Replaces Carrier #: 17-40033-05)

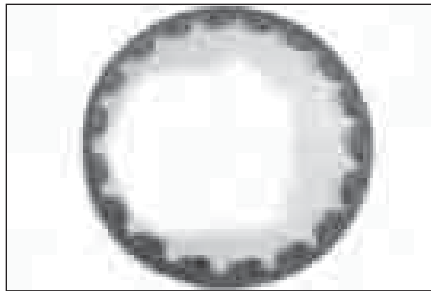

Gasket, Cover
 Order Part #: P-17-40029-05
 (Replaces Carrier #: 17-40029-05)

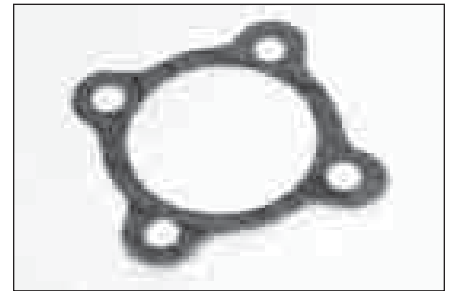

Gasket, Cover
 Order Part #: P-17-40075-05
 (Replaces Carrier #: 17-40075-05)

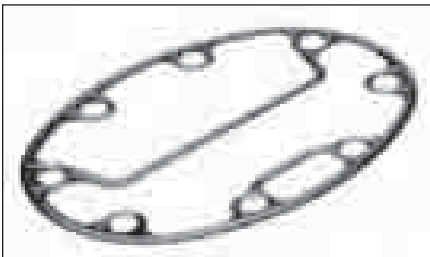

Gasket, Head Center
 Order Part #: P-17-44123-00
 (Replaces Carrier #: 17-44123-00)

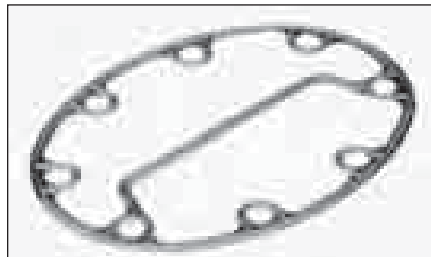

Gasket, Head w/o Unloaders
 Order Part #: P-17-44124-00
 (Replaces Carrier #: 17-44124-00)

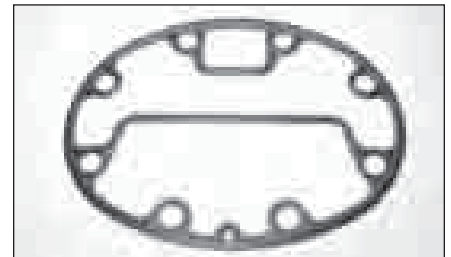

Gasket, Head
 Order Part #: P-17-44126-00
 (Replaces Carrier #: 17-44126-00)

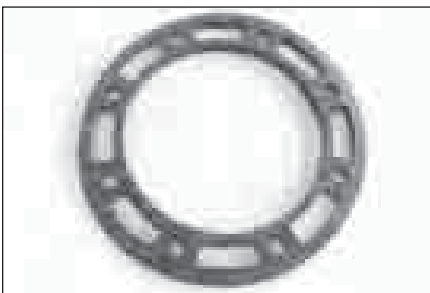

Gasket, Pump End
 Order Part #: P-17-40078-05
 (Replaces Carrier #: 17-40078-05)

CONTAINER Parts

CONTAINER COMPRESSOR PARTS (continued)

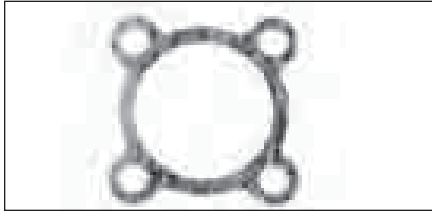

Gasket, Service Valve (Suction)

Part #: P-17-40005-05
(Replaces Carrier #: 17-40005-05)

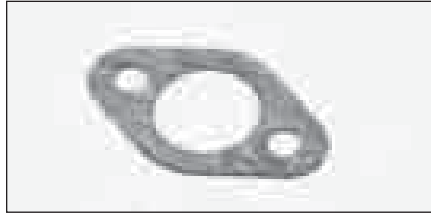

Gasket, Service Valve (Discharge) Fiber

Order Part #: P-17-44138-00
(Replaces Carrier #: 17-44138-00)

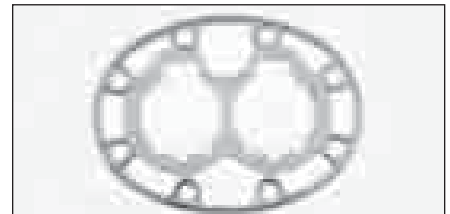

Gasket, Valve Plate

Order Part #: P-17-44007-06
(Replaces Carrier #: 17-44007-06)



Gasket, Sight Glass

Order Part #: P-17-10218-02
(Replaces Carrier #: 17-10218-02)

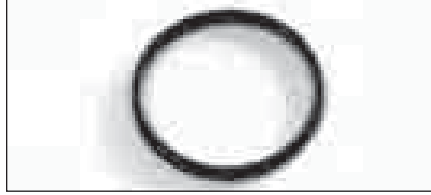

O-Ring

Order Part #: P-17-55022-00
(Replaces Carrier #: 17-55022-00)



Pin Dowel

Order Part #: P-17-40057-00
(Replaces Carrier #: 17-40057-00)



Piston, Contour Head (Std) 37 CFM

Order Part #: P-17-44016-05
(Replaces Carrier #: 17-44016-05)



Piston, 2 Ring, Cont Head (Std) 41 CFM

Order Part #: P-17-44115-01
(Replaces Carrier #: 17-44115-01)

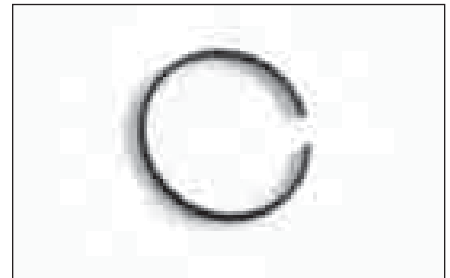

Ring, Piston

Order Part #: P-17-40055-00
(Replaces Carrier #: 17-40055-00)

Piston, Contour Head (+.020")

Order Part #: P-17-44016-07
(Replaces Carrier #: 17-44016-07)

Piston, 2 Ring, Cont Head (+.020")

Order Part #: P-17-44115-20
(Replaces Carrier #: 17-44115-20)

Ring, Piston (+.020")

Order Part #: P-17-55025-00
(Replaces Carrier #: 17-55025-00)

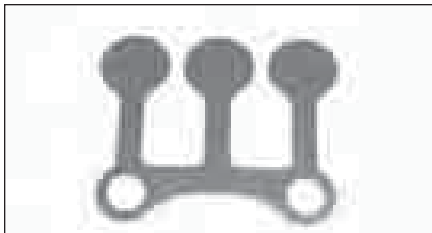

Reed, Discharge (Hi Eff)

Order Part #: P-06DA502-913
(Replaces Carrier #: 06DA502-913)



Reed, Suction (Hi Eff)

Order Part #: P-06DA502-903
(Replaces Carrier #: 06DA502-903)

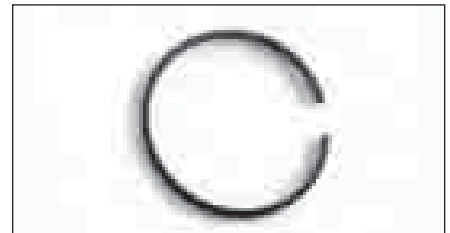

Ring, Oil (only for older 37cfm pistons w/wider lower groove)

Order Part #: P-17-40054-00
(Replaces Carrier #: 17-40054-00)

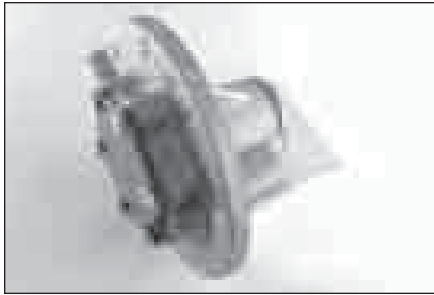

Pump, Oil (Universal Gear)
 Order Part #: P-17-44137-00
 (Replaces Carrier #: 17-44137-00)

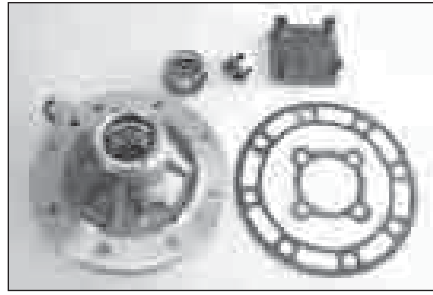

Pump, Oil (Vane)
 Order Part #: P-17-40200-02
 (Replaces Carrier #: 17-40200-02)



Rod, Connecting (Std)
 Order Part #: P-17-40056-02
 (Replaces Carrier #: 17-40056-02)

Rod, Connecting (+.010")
 Order Part #: P-17-55023-00
 (Replaces Carrier #: 17-55023-00)

Rod, Connecting (+.020")
 Order Part #: P-17-ROD020-05G

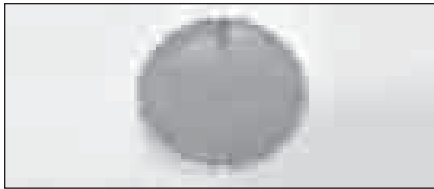

Screen, Oil Filter
 Order Part #: P-17-40020-00
 (Replaces Carrier #: 17-40020-00)



Sightglass
 Order Part #: P-17-10218-00
 (Replaces Carrier #: 17-10218-00)

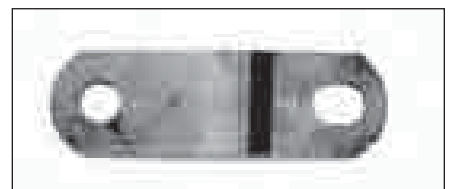

Spring, Suction Valve
 Order Part #: P-17-40083-00
 (Replaces Carrier #: 17-40083-00)



Strainer, Suction (05G)
 Order Part #: P-17-44005-00
 (Replaces Carrier #: 17-44005-00)

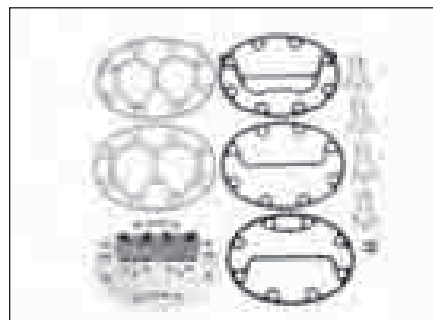

Valve Plate (Canted, Center or Side Bank)
 Order Part #: P-17-44105-00
 (Replaces Carrier #: 17-44105-00)

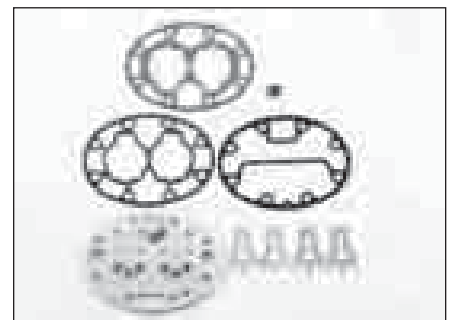

Valve Plate (Canted, Side Bank w/HGBP)
 Order Part #: P-17-44104-00
 (Replaces Carrier #: 17-44104-00)



Valve Plate (Flat, Ctr or Side w/Suc. cutoff)
 Order Part #: P-17-44107-00
 (Replaces Carrier #: 17-44107-00)

CONTAINER

CONTAINER Parts

CONTAINER COMPRESSOR PARTS (continued)

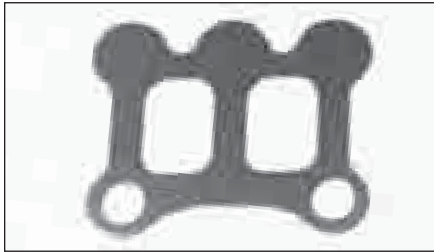

Valve, Discharge

Order Part #: P-17-40086-00
(Replaces Carrier #: 17-40086-00)

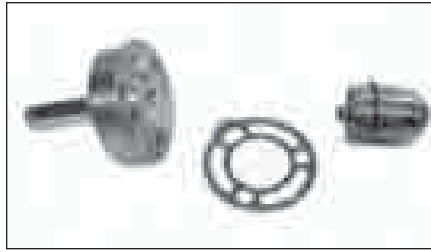

Valve, Unloader

Order Part #: P-17-40417-00
(Replaces Carrier #: 17-40417-00)



Valve, Suction (05G)

Order Part #: P-17-44111-00
(Replaces Carrier #: 17-44111-00)

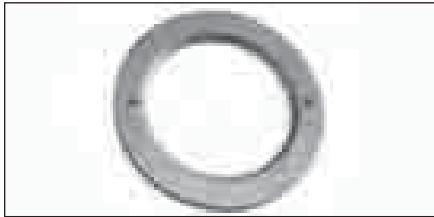

Washer, Thrust (Pump End)

Order Part #: P-17-55009-01
(Replaces Carrier #: 17-55009-01)

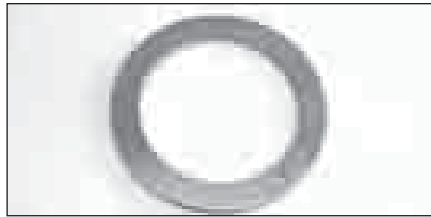

Washer, Thrust (Seal End)

Order Part #: P-17-44008-00
(Replaces Carrier #: 17-44008-00)

CONTAINER ENGINE PARTS



Bearing Set, Main #1-#5 (-0.2MM)

Order Part #: P-25-38126-01-B
(Replaces Carrier #: 25-38126-01)

Bearing Set, Main #1-#5 (-0.4MM)

Order Part #: P-25-38126-02-B
(Replaces Carrier #: 25-38126-02)



Bearing, Main #1(Std)

Order Part #: P-25-39120-00-B
(Replaces Carrier #: 25-39120-00)

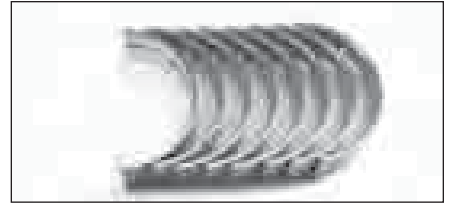

Bearing, Main #2-#5 (Std)

Order Part #: P-25-39121-00-B
(Replaces Carrier #: 25-39121-00)



Bearing, Rod (Std)

Order Part #: P-25-39122-00-B
(Replaces Carrier #: 25-39122-00)

Bearing, Rod (-0.2MM)

Order Part #: P-25-38122-01-B
(Replaces Carrier #: 25-38122-01)

Bearing, Rod (-0.4MM)

Order Part #: P-25-38122-02-B
(Replaces Carrier #: 25-38122-02)

CONTAINER ENGINE PARTS (continued)

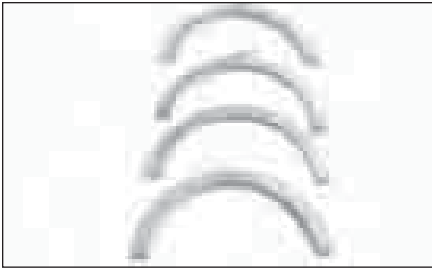

Bearing, Thrust (Std)
 Order Part #: P-25-37399-00-B
 (Replaces Carrier #: 25-37399-00)



Bushing, Piston Pin
 Order Part #: P-25-38121-00-B
 (Replaces Carrier #: 25-38121-00)

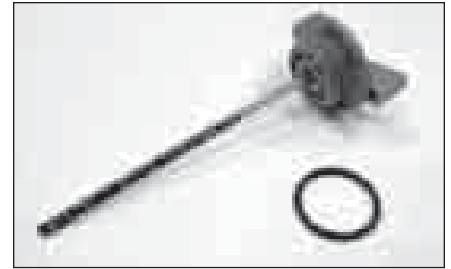

Dipstick
 Order Part #: P-25-37085-00
 (Replaces Carrier #: 25-37085-00)

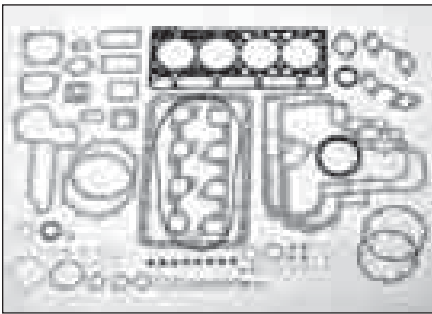

Gasket Set (133 & 134DI)
 Order Part #: P-25-38513-00
 (Replaces Carrier #: 25-38513-00)

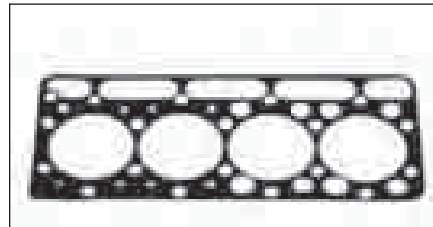

Gasket, Head (134DI)
 Order Part #: P-25-38529-01-B
 (Replaces Carrier #: 25-38529-01)



Injector, Fuel
 Order Part #: P-25-38640-00
 (Replaces Carrier #: 25-38640-00)



Piston Assy w/o Rings (Std) (134DI)
 Order Part #: P-25-39127-01-B
 (Replaces Carrier #: 25-39127-01)

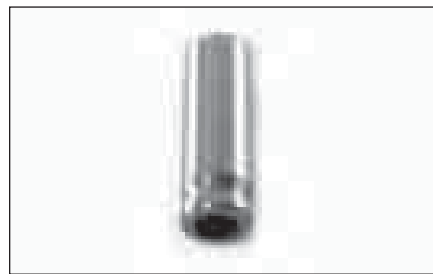

Guide, Exhaust Valve
 Order Part #: P-25-39037-00-B
 (Replaces Carrier #: 25-39037-00)



Guide, Intake Valve
 Order Part #: P-25-39036-00
 (Replaces Carrier #: 25-39036-00)

Piston Assy w/o Rings (+0.5MM) (134DI)
 Order Part #: P-25-39128-01-B
 (Replaces Carrier #: 25-39128-01)

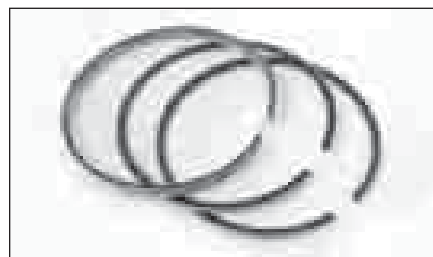

Ring Set, Piston (Std)
 Order Part #: P-25-38611-00
 (Replaces Carrier #: 25-38611-00)
Ring Set, Piston (+ 0.5MM)
 Order Part #: P-25-38611-01-B
 (Replaces Carrier #: 25-38611-01-B)

CONTAINER

CONTAINER Parts

CONTAINER ENGINE PARTS (continued)



Plug, Expansion

Order Part #: P-25-37107-00
(Replaces Carrier #: 25-37107-00)

Plug, Expansion

Order Part #: P-25-37032-00
(Replaces Carrier #: 25-37032-00)

Plug, Expansion

Order Part #: P-25-37033-00
(Replaces Carrier #: 25-37033-00)



Plug Set, Expansion (Block)

Order Part #: P-25-37020-00
(Replaces Carrier #: 25-37020-00)

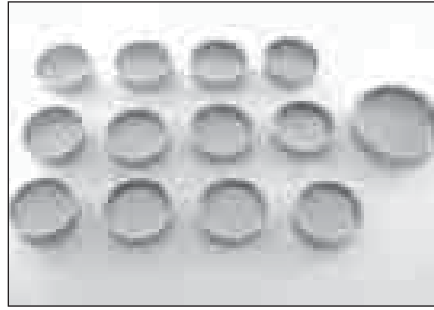

Plug Set, Expansion (Head)

Order Part #: P-25-37021-00
(Replaces Carrier #: 25-37021-00)



Plug, Glow

Order Part #: P-25-38150-01-B
(Replaces Carrier #: 25-38150-01)



Pump, Oil (w/gasket)

Order Part #: P-25-37040-00
(Replaces Carrier #: 25-37040-00)



Gasket, Oil Pump (CT4 engines, except 91)

Order Part #: P-25-37041-00
(Replaces Carrier #: 25-37041-00)



Pump, Fuel Assembly

Order Part #: P-25-38666-00
(Replaces Carrier #: 25-38666-00)

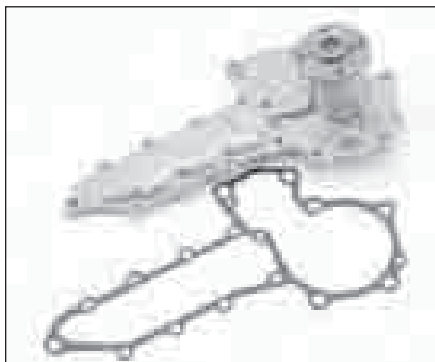

Pump, Water

Order Part #: P-25-37581-10-B
(Replaces Carrier #: 25-37581-10)



Pump, Priming

Order Part #: P-25-38666-11
(Replaces Carrier #: 25-38666-11)

CONTAINER Parts

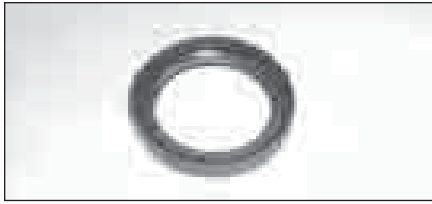

Seal, Oil (Front)

Order Part #: P-25-37396-01-B
(Replaces Carrier #: 25-37396-01)



Sleeve, Wear (Front)

Order Part #: P-25-37388-00-B
(Replaces Carrier #: 25-37388-00)

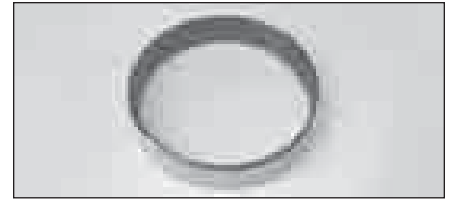

Sleeve, Wear (Rear)

Order Part #: P-25-37385-02-B
(Replaces Carrier #: 25-37382-02)



Thermostat, Water w/Gasket

Order Part #: P-25-37559-01
(Replaces Carrier #: 25-37559-01)

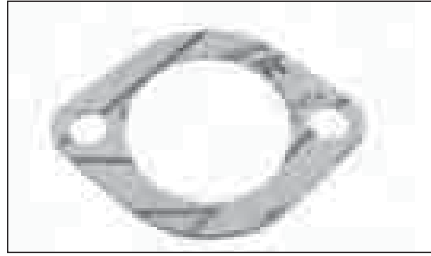

Gasket, Thermostat

Order Part #: P-25-37558-00
(Replaces Carrier #: 25-37558-00)

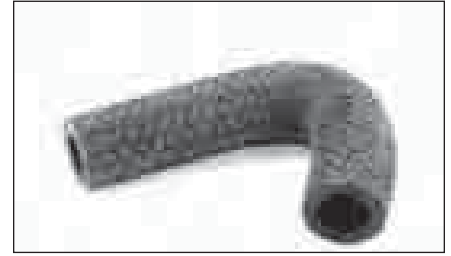

Tube, Water Return

Order Part #: P-25-37556-00
(Replaces Carrier #: 25-37556-00)

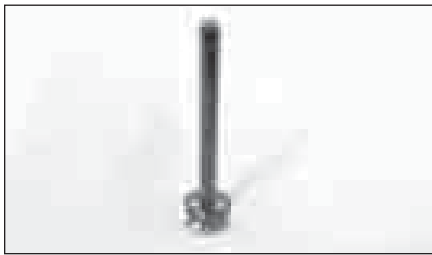

Valve, Exhaust

Order Part #: P-25-38086-00-B
(Replaces Carrier #: 25-38086-00)

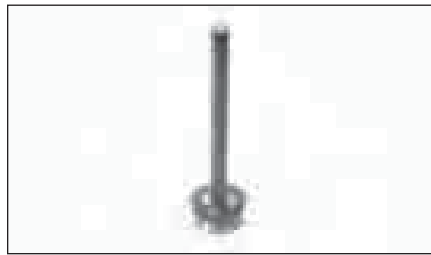

Valve, Intake

Order Part #: P-25-38085-00-B
(Replaces Carrier #: 25-38085-00)

CONTAINER GENERAL PARTS

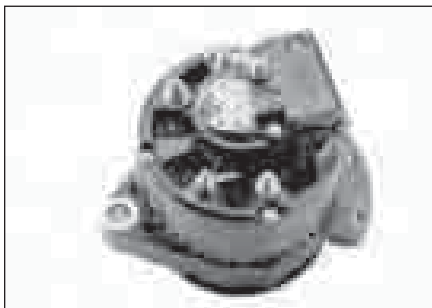

Alternator (65A)

Order Part #: P-30-00423-00
(Replaces Carrier #: 30-00423-00)

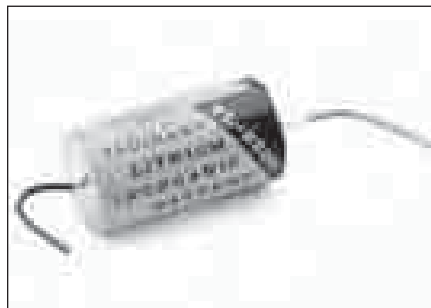

Battery, Lithium (3.6V)

Order Part #: P-12-01084-07
(Replaces Carrier #: 12-01084-07)

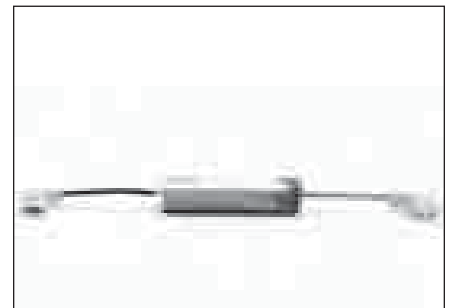

Battery, Lithium (3.6V)

Order Part #: P-22-50051-00
(Replaces Carrier #: 22-50051-00)

CONTAINER Parts

CONTAINER GENERAL PARTS (continued)

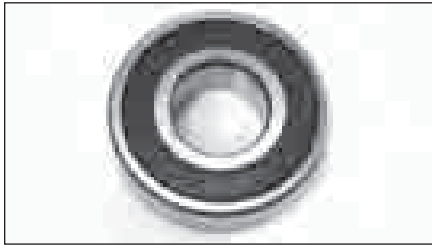

Bearing, Idler

Order Part #: P-04-00018-00
(Replaces Carrier #: 04-00018-00)

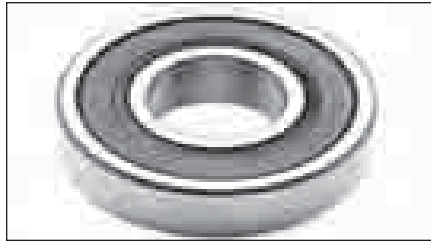

Bearing, Alternator, Front

Order Part #: P-30-00423-28
(Replaces Carrier #: 30-00423-28)

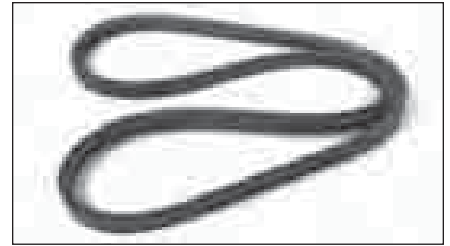

Belt, Alternator

Order Part #: P-50-00204-01
(Replaces Carrier #: 50-00204-01)

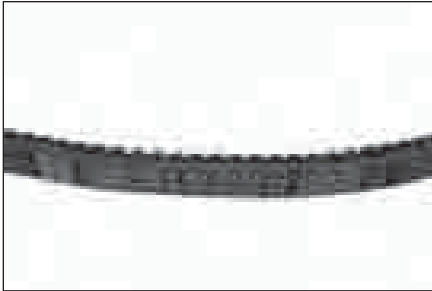

Belt, Water Pump

Order Part #: P-50-00162-04
(Replaces Carrier #: 50-00162-04)

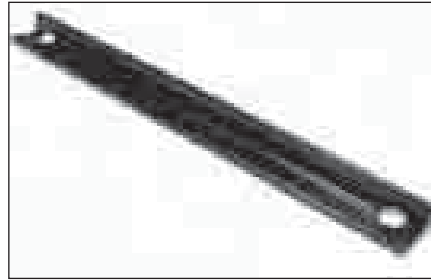

Bracket, Battery Hold Down

Order Part #: P-68-13945-00
(Replaces Carrier #: 68-13945-00)



Breaker, Circuit

Order Part #: P-66U1-7842-13
(Replaces Carrier #: 66U1-7842-13)



Breaker, Circuit (48A, 230V)

Order Part #: P-66U1-7842-2
(Replaces Carrier #: 66U1-7842-2)

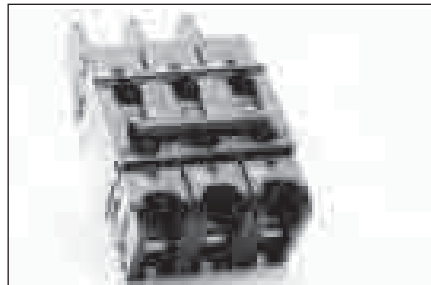

Breaker, Circuit (CB1)

Order Part #: P-66U1-1723-3
(Replaces Carrier #: 66U1-1723-3)

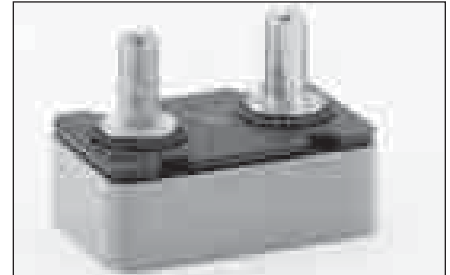

Breaker, Circuit (CB2, 30A, 12V)

Order Part #: P-10-00171-12
(Replaces Carrier #: 10-00171-12)



Breaker, Circuit (CB2)

Order Part #: P-10-00277-00
(Replaces Carrier #: 10-00277-00)

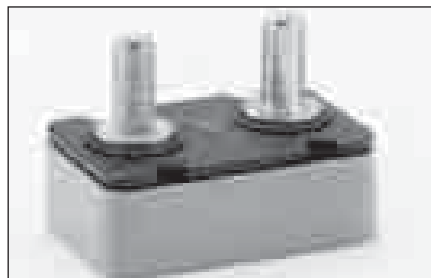

Breaker, Circuit (CB3, 50A, 12V)

Order Part #: P-10-00171-13
(Replaces Carrier #: 10-00171-13)

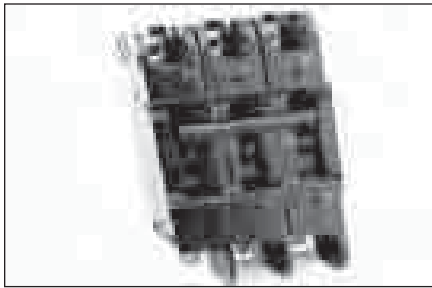

**Breaker, Circuit
(Comp., 460V)**

Order Part #: P-66U1-1723-2
(Replaces Carrier #: 66U1-1723-2)



**Breaker, Circuit
(Start/Stop)**

Order Part #: P-66U1-3683
(Replaces Carrier #: 66U1-3683)

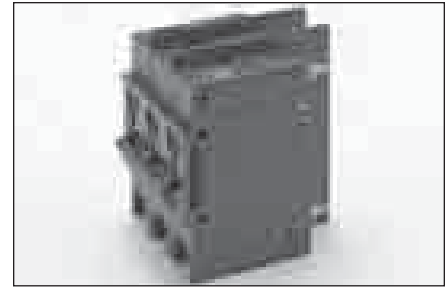

Breaker, Circuit

Order Part #: P-66U1-7842-5
(Replaces Carrier #: 66U1-7842-5)



**Breaker, Current
(On/Off, 12A)**

Order Part #: P-10-00360-01
(Replaces Carrier #: 10-00360-01)

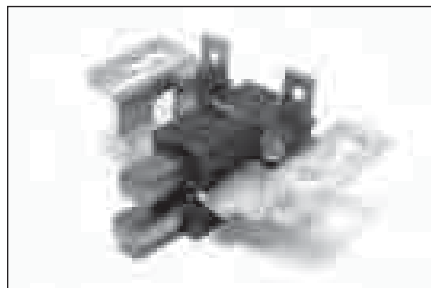

Brush Assembly, Alternator

Order Part #: P-30-00409-30
(Replaces Carrier #: 30-00409-30)



Cap, Coupling

Order Part #: P-40-00520-02
(Replaces Carrier #: 40-00520-02)



Cap, Coupling

Order Part #: P-40-00520-03
(Replaces Carrier #: 40-00520-03)



Cap, Radiator

Order Part #: P-30-00397-00
(Replaces Carrier #: 30-00397-00)



Cap, Service Valve

Order Part #: P-17-10812-00
(Replaces Carrier #: 17-10812-00)

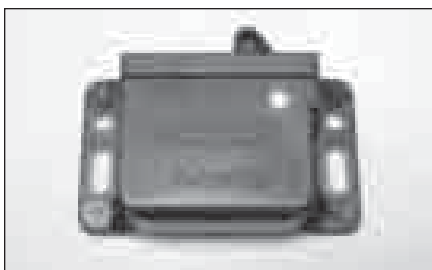

Catch, Latch

Order Part #: P-44-00340-05
(Replaces Carrier #: 44-00340-05)

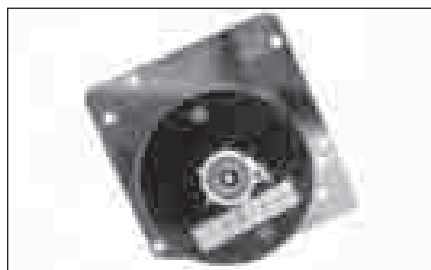

Clock, 31 Day (CCW)

Order Part #: P-09-00123-00
(Replaces Carrier #: 09-00123-00)

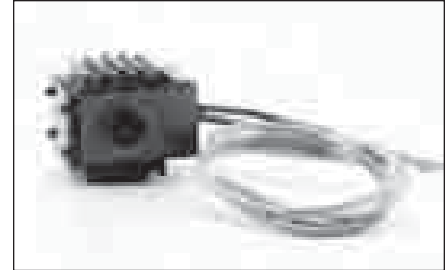

Coil, Solenoid (24VAC)

Order Part #: P-14-01091-01
(Replaces Carrier #: 14-01091-01)

CONTAINER Parts

CONTAINER GENERAL PARTS (continued)

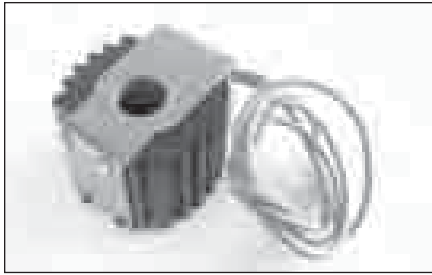

Coil, Solenoid (24VDC)

Order Part #: P-14-01091-02
(Replaces Carrier #: 14-01091-02)



Coil, Condenser (Copper/Copper)

Order Part #: P-69NT43-202-10SV
(Replaces Carrier #: 69NT43-202-10SV)



Coil, Condenser (Copper/Aluminum)

Order Part #: P-69NT43-202-20SV
(Replaces Carrier #: 69NT43-202-20SV)



Coil, Solenoid Valve

Order Part #: P-14-50021-02
(Replaces Carrier #: 14-50021-02)



Contactor W/Aux (40A)

Order Part #: P-10-00304-33SV
(Replaces Carrier #: 10-00304-33SV)

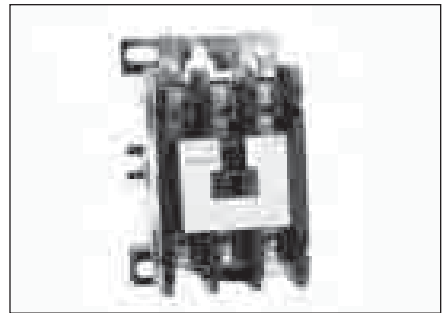

Contactor, Compressor (40A)

Order Part #: P-10-00304-33
(Replaces Carrier #: 10-00304-33)

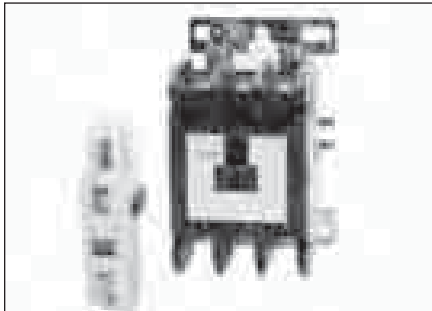

Contactor, Fan, W/Aux (15A)

Order Part #: P-10-00304-32SV
(Replaces Carrier #: 10-00304-32SV)



Coupling, Hi

Order Part #: P-40-00520-01
(Replaces Carrier #: 40-00520-01)



Drier, Filter (Single)

Order Part #: P-14-00284-02SV
(Replaces Carrier #: 14-00284-02SV)

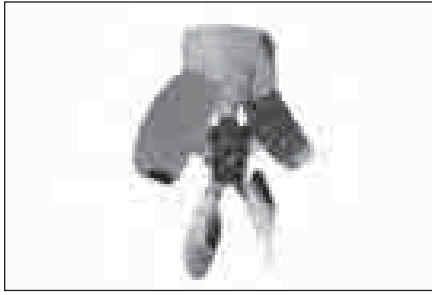

Fan, Cond., 16" Propeller
 Order Part #: P-38-00511-00SV
 (Replaces Carrier #: 38-00511-00SV)

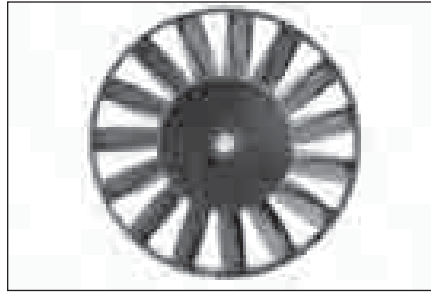

Fan, Cond., 17.5" (Composite)
 Order Part #: P-38-00503-00
 (Replaces Carrier #: 38-00503-00)

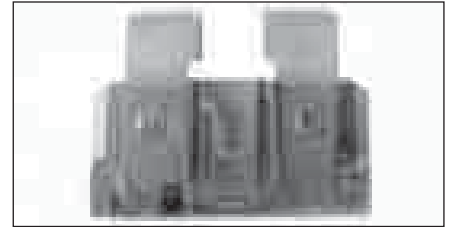

Fuse, Blade (2A)
 Order Part #: 41-2543
 (Replaces Carrier #: 22-02336-07)

Fuse, Blade (3A)
 Order Part #: 44-9524
 (Replaces Carrier #: 22-02336-03)

Fuse, Blade (5A)
 Order Part #: P-22-02336-02
 (Replaces Carrier #: 22-02336-02)

Fuse, Blade (10A)
 Order Part #: P-22-02336-04
 (Replaces Carrier #: 22-02336-04)

Fuse, Blade (15A)
 Order Part #: P-22-02336-06
 (Replaces Carrier #: 22-02336-06)

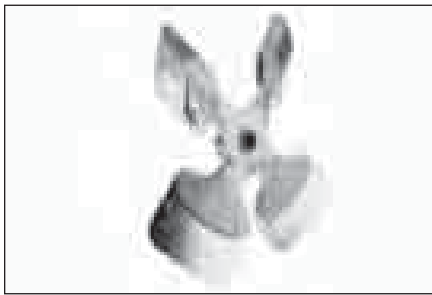

Fan, Evap, 13" Prop, LH
 Order Part #: P-38-00126-00
 (Replaces Carrier #: 38-00126-00)



Fan, Evap, 13" Prop, RH
 Order Part #: P-38-00125-00
 (Replaces Carrier #: 38-00125-00)



Filter, Oil
 Order Part #: P-30-00323-00
 (Replaces Carrier #: 30-00323-00)



Drain Cock
 Order Part #: P-25-37593-00
 (Replaces Carrier #: 25-37593-00)



Fuse, Glass, Slow Blow (1A)
 Order Part #: P-22-00060-22
 (Replaces Carrier #: 22-00060-22)

Fuse, Glass, Slow Blow (3A)
 Order Part #: P-HY-10FJ-203
 (Replaces Carrier #: HY-10FJ-203)

Fuse, Glass, 1" (3A)
 Order Part #: P-22-00060-20
 (Replaces Carrier #: 22-00060-20)

Fuse, Glass, Slow Blow (5A)
 Order Part #: P-22-00060-21
 (Replaces Carrier #: 22-00060-21)

Fuse, Glass, Slow Blow (6A)
 Order Part #: P-22-60288-10
 (Replaces Carrier #: 22-60288-10)



Gauge, Fuel
 Order Part #: P-12-01098-04
 (Replaces Carrier #: 12-01098-04)

CONTAINER Parts

CONTAINER GENERAL PARTS (continued)



Gauge, Oil Pressure

Order Part #: P-66U1-2823
(Replaces Carrier #: 66U1-2823)

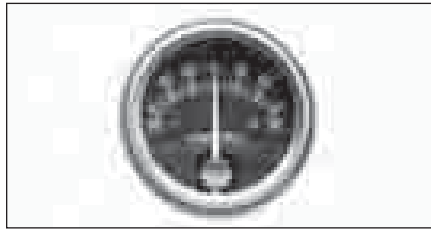

Gauge, Ammeter (+60A/-60A)

Order Part #: P-22-00538-01SV
(Replaces Carrier #: 22-00538-01SV)



Gauge, Water Temp

Order Part #: P-12-00097-03
(Replaces Carrier #: 12-00097-03)

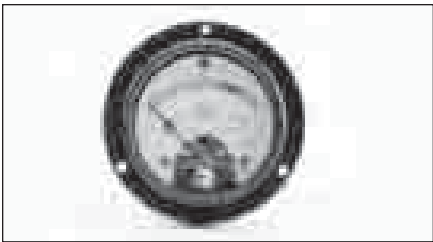

Gauge, Voltmeter

Order Part #: P-22-00462-00
(Replaces Carrier #: 22-00462-00)



Heater, Drain Pan, 19" (49CM)

Order Part #: P-24-00002-00
(Replaces Carrier #: 24-00002-00)

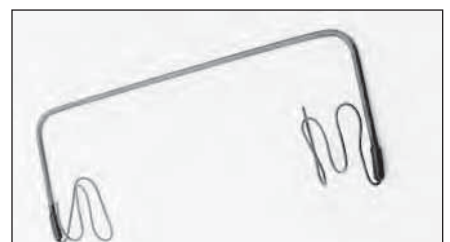

Heater, Drain Pan, 24" (61CM)

Order Part #: P-24-00003-00
(Replaces Carrier #: 24-00003-00)

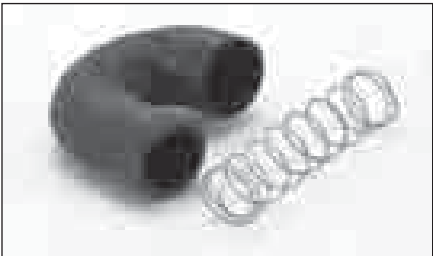

Hose, Formed (AIR)

Order Part #: P-58-00976-00
(Replaces Carrier #: 58-00976-00)



Hose, Formed (AIR)

Order Part #: P-58-04203-01
(Replaces Carrier #: 58-04203-01)



Hose, Formed (Eng to Rad)

Order Part #: P-58-04216-00
(Replaces Carrier #: 58-04216-00)



Indicator, Moisture

Order Part #: P-14-01092-03
(Replaces Carrier #: 14-01092-03)



Indicator, Sightglass

Order Part #: P-14-00220-00
(Replaces Carrier #: 14-00220-00)



J-Bolt, Battery

Order Part #: P-34-06058-06
(Replaces Carrier #: 34-06058-06)

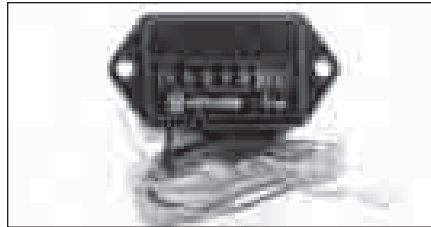

Meter, Hour, Mini

Order Part #: P-10-00363-00
(Replaces Carrier #: 10-00363-00)

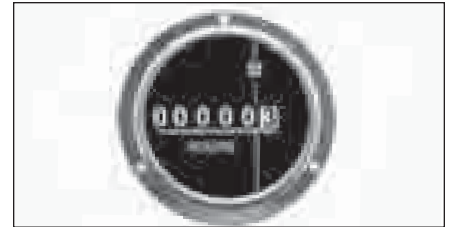

Meter, Hour

Order Part #: P-66U1-3823
(Replaces Carrier #: 66U1-3823)

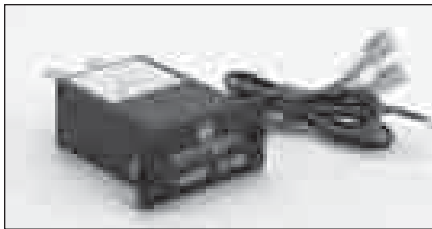

Meter, Hour

Order Part #: P-10-00363-01
(Replaces Carrier #: 10-00363-01)

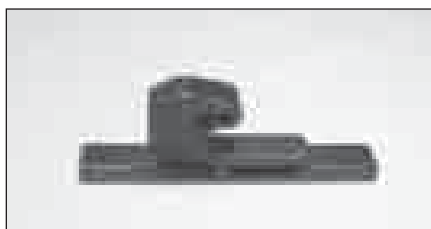

Keeper, Latch

Order Part #: P-44-00340-03
(Replaces Carrier #: 44-00340-03)

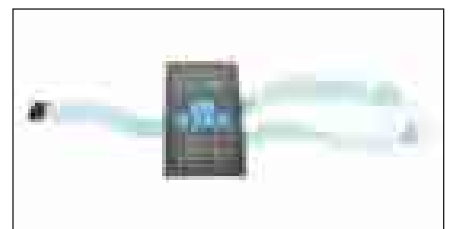

Keypad

Order Part #: P-79-01706-03SV
(Replaces Carrier #: 79-01706-03SV)

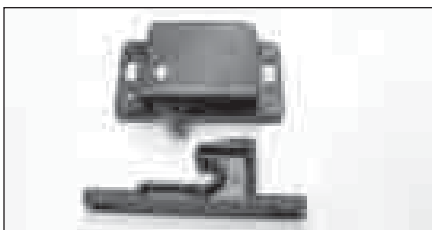

Latch Kit

Order Part #: P-44-00340-04
(Replaces Carrier #: 44-00340-04)



Oil, Comp (Alkylbenzene)

Order Part #: 67-404 (Case of 12)
66-404 (One Gallon)
(Replaces Carrier #: 07-00274-00)



Oil, Comp (Polyolester)

Order Part #: P-07-00317-00
(Replaces Carrier #: 07-00317-00)



Pack, Battery

Order Part #: P-30-00407-02SV
(Replaces Carrier #: 30-00407-02SV)

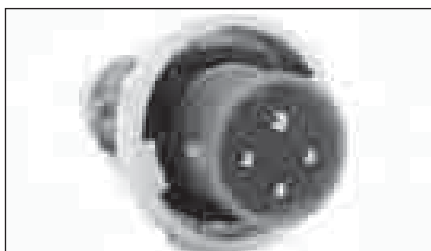

Plug 32AMP 500V

Order Part #: 41-1976
(Replaces Carrier #: 22-02378-00)

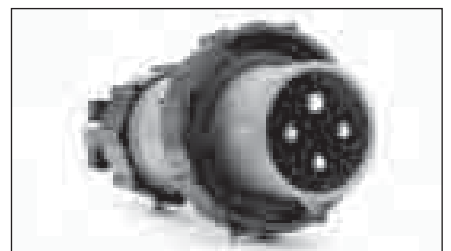

Plug, Power

Order Part #: P-66U1-3123-1
(Replaces Carrier #: 66U1-3123-1)

CONTAINER Parts

CONTAINER GENERAL PARTS (continued)

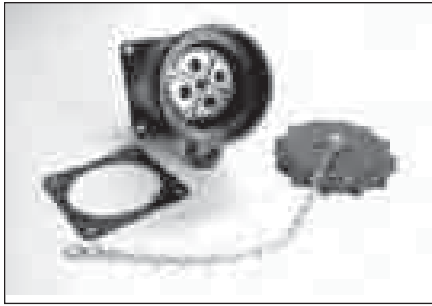

Receptacle (60A, 250V)

Order Part #: P-66U1-3863-1
(Replaces Carrier #: 66U1-3863-1)

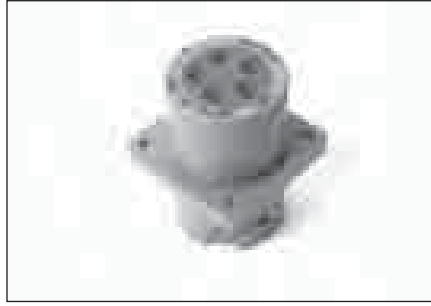

Receptacle, 5-Pin

Order Part #: 41-2405
(Replaces Carrier #: 22-01660-03)



Recorder Mechanism Assembly

Order Part #: P-09-00147-00
(Replaces Carrier #: 09-00147-00)

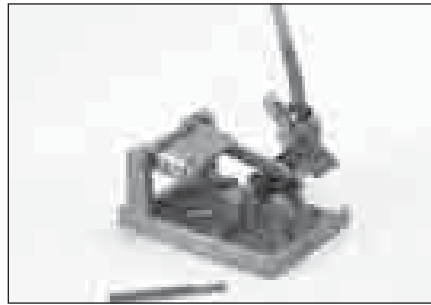

Recorder Mechanism Assembly

Order Part #: P-09-00280-00
(Replaces Carrier #: 09-00280-00)

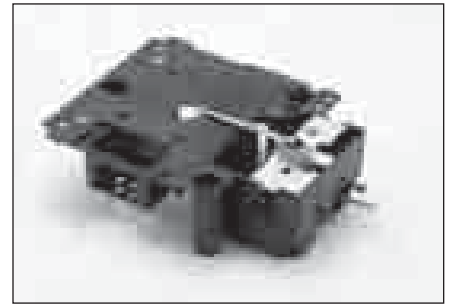

Recorder Mechanism Assembly

Order Part #: P-09-00296-00
(Replaces Carrier #: 09-00296-00)

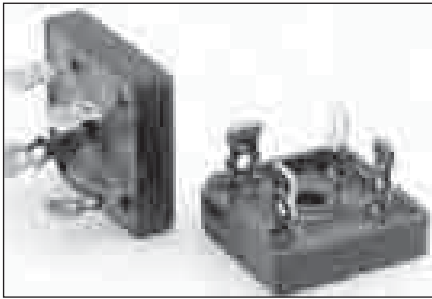

Rectifier, Charging System

Order Part #: P-10-01120-00
(Replaces Carrier #: 10-01120-00)



Regulator, Voltage

Order Part #: P-30-00423-02
(Replaces Carrier #: 30-00423-02)

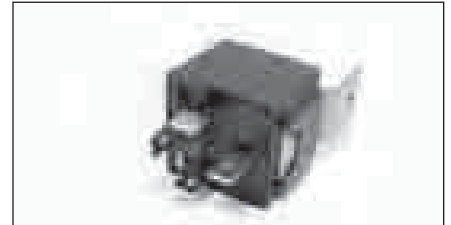

Relay

Order Part #: P-10-00286-03
(Replaces Carrier #: 10-00286-03)

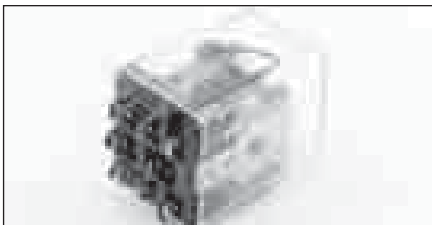

Relay, Starter Solenoid (12V)

Order Part #: P-10-00220-00
(Replaces Carrier #: 10-00220-00)

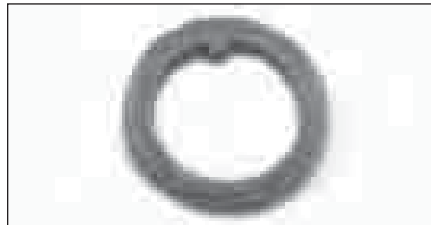

Seal, Boot, Switch

Order Part #: P-66U1-9752
(Replaces Carrier #: 66U1-9752)

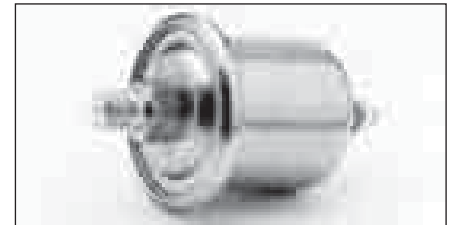

Sender, Oil Pressure

Order Part #: P-66U1-2543-2
(Replaces Carrier #: 66U1-2543-2)

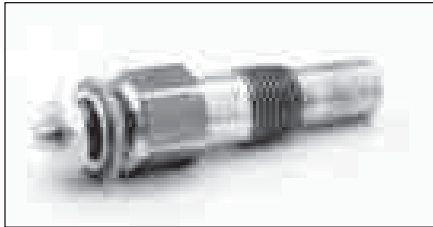

Sender, Water Temp

Order Part #: P-12-00098-04
(Replaces Carrier #: 12-00098-04)

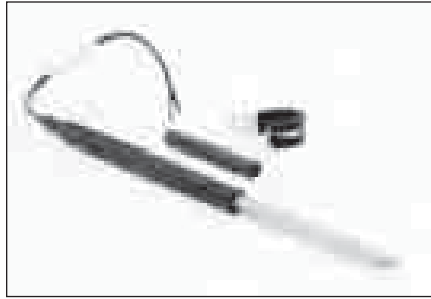

Sensor, Thermistor (RRS/RTS)

Order Part #: P-12-00395-01SV
(Replaces Carrier #: 12-00395-01SV)



Sensor, Thermistor (USDA Probe)

Order Part #: P-12-00342-02
(Replaces Carrier #: 12-00342-02)



Sensor, Thermistor (USDA Probe)

Order Part #: P-12-00342-03
(Replaces Carrier #: 12-00342-03)



Sensor, Thermostat

Order Part #: P-12-01072-11SV
(Replaces Carrier #: 12-01072-11SV)



Starter, 1 pc Oil Pan

Order Part #: P-25-38750-00
(Replaces Carrier #: 25-38750-00)



Switch

Order Part #: P-69NT35-438
(Replaces Carrier #: 69NT35-438)



Switch

Order Part #: P-69NT35-763
(Replaces Carrier #: 69NT35-763)



Switch Assembly (TDS & TSS)

Order Part #: P-69NT35-963
(Replaces Carrier #: 69NT35-963)



Switch, Pressure (350PSIG, HPS)

Order Part #: P-12-00309-00
(Replaces Carrier #: 12-00309-00)

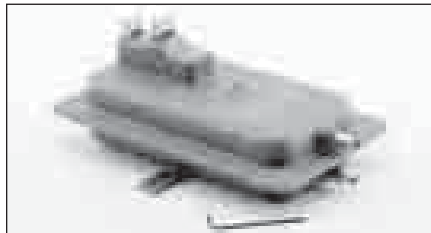

Switch, Pressure (Air)

Order Part #: P-66U1-2513
(Replaces Carrier #: 66U1-2513)

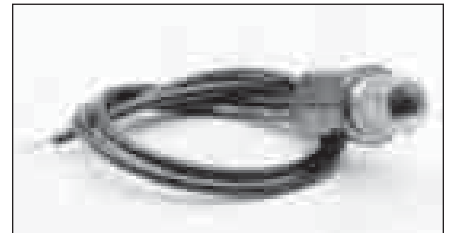

Switch, Pressure (Water)

Order Part #: P-12-01071-01SV
(Replaces Carrier #: 12-01071-01SV)

CONTAINER Parts

CONTAINER GENERAL PARTS (continued)



Switch, Push Button (PTS)

Order Part #: P-69NT40-123
(Replaces Carrier #: 69NT40-123)



Switch, Push Button (TDS)

Order Part #: P-69NT35-926
(Replaces Carrier #: 69NT35-926)



Switch, Push Button

Order Part #: P-10-01142-02
(Replaces Carrier #: 10-01142-02)

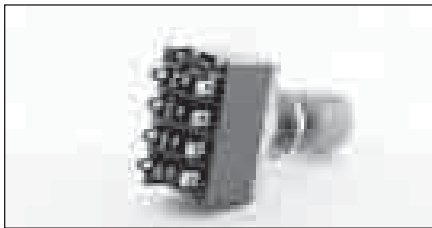

Switch, Push Button

Order Part #: P-10-01142-03
(Replaces Carrier #: 10-01142-03)



Switch, Pressure (HPS)

Order Part #: P-66U1-6942-4
(Replaces Carrier #: 66U1-6942-4)

Switch, Pressure (VHPS)

Order Part #: P-66U1-6942-6
(Replaces Carrier #: 66U1-6942-6)

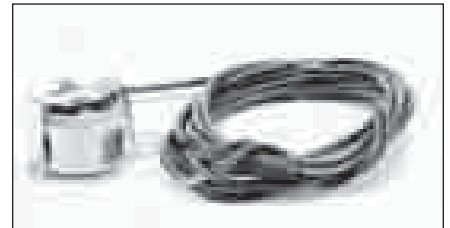

Switch, Themostat (DTT)

Order Part #: P-66U1-6912-8
(Replaces Carrier #: 66U1-6912-8)

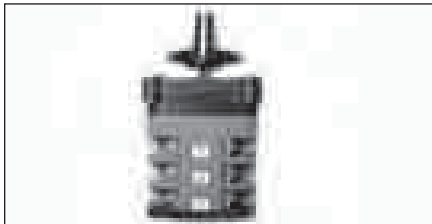

Switch, Rotary

Order Part #: P-10-01128-00
(Replaces Carrier #: 10-01128-00)

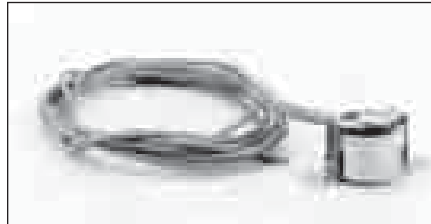

Switch, Themostat (HTT)

Order Part #: P-66U1-6912-7
(Replaces Carrier #: 66U1-6912-7)



Switch, Toggle (BMS)

Order Part #: P-10-01130-07
(Replaces Carrier #: 10-01130-07)



Switch, Toggle (Cond. Fan)

Order Part #: P-10-00298-01
(Replaces Carrier #: 10-00298-01)

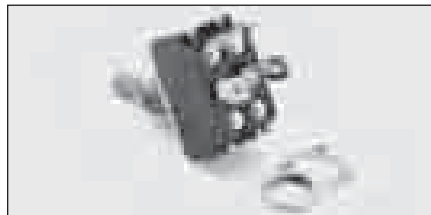

Switch, Toggle (GP)

Order Part #: P-10-01129-13
(Replaces Carrier #: 10-01129-13)



Switch, Toggle (IGN)

Order Part #: P-10-00222-00
(Replaces Carrier #: 10-00222-00)

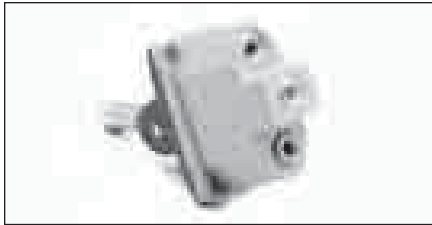

Switch, Toggle (MDS)
 Order Part #: P-10-00221-00
 (Replaces Carrier #: 10-00221-00)



Switch, Toggle (MDS)
 Order Part #: P-10-01129-10
 (Replaces Carrier #: 10-01129-10)

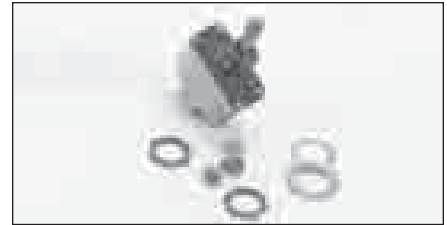

Switch, Toggle (ON/OFF)
 Order Part #: P-10-00237-00
 (Replaces Carrier #: 10-00237-00)



Switch, Toggle (TSS)
 Order Part #: P-69NT35-916
 (Replaces Carrier #: 69NT35-916)

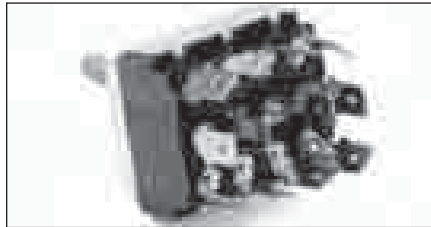

Switch, Toggle, On/Off (EB)
 Order Part #: P-10-01129-07SV
 (Replaces Carrier #: 10-01129-07SV)

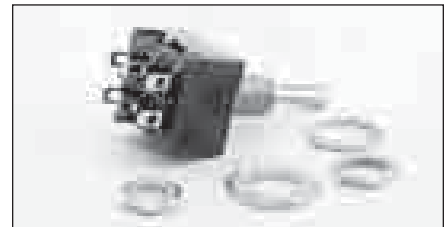

Switch, Toggle, On/Off (TSS)
 Order Part #: P-10-01146-01
 (Replaces Carrier #: 10-01146-01)

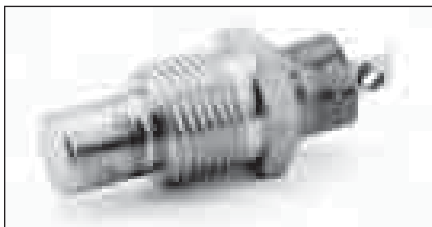

Switch, Water Temp (110C/230F)
 Order Part #: P-10-00158-02
 (Replaces Carrier #: 10-00158-02)

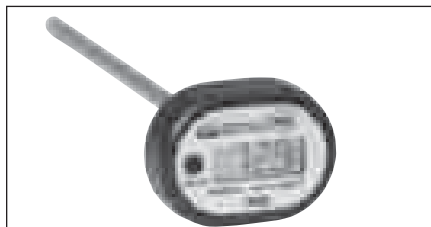

Thermometer, POCKET Digital(C)
 Order Part #: P-300AC
 (Replaces Carrier #: 300AC)

Thermometer, POCKET Digital(F)
 Order Part #: P-300A
 (Replaces Carrier #: 300A)



Timer, Delay
 Order Part #: P-12-01087-00
 (Replaces Carrier #: 12-01087-00)



Transducer, Pressure
 Order Part #: P-12-00352-00
 (Replaces Carrier #: 12-00352-00)

PG Parts offers quality Thermo King parts for your Carrier container, bus, truck and trailer units.

Talk to your local Thermo King dealer today about how they can help you with Carrier parts or service.

CONTAINER

CONTAINER Parts

CONTAINER GENERAL PARTS (continued)

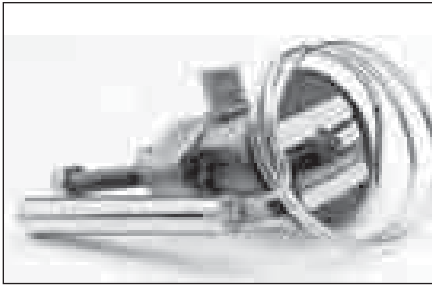

Valve (TXV)

Order Part #: P-14-01104-42
(Replaces Carrier #: 14-01104-42)



Valve (TXV) Less Flange

Order Part #: P-14-01104-03
(Replaces Carrier #: 14-01104-03)

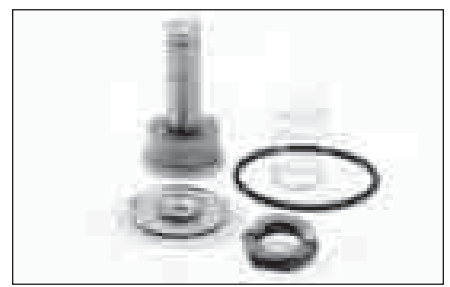

Valve Repair Kit

Order Part #: P-14-50045-00
(Replaces Carrier #: 14-50045-00)



Valve, Pressure (500PSIG)

Order Part #: P-14-00215-03
(Replaces Carrier #: 14-00215-03)



Valve, Service 1-1/8

Order Part #: P-14-01042-06
(Replaces Carrier #: 14-01042-06)

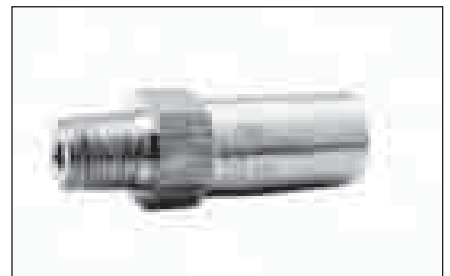

Valve, Relief (265 PSIG)

Order Part #: P-14-00195-02
(Replaces Carrier #: 14-00195-02)



Valve, Relief (340 PSIG)

Order Part #: P-14-00195-01
(Replaces Carrier #: 14-00195-01)

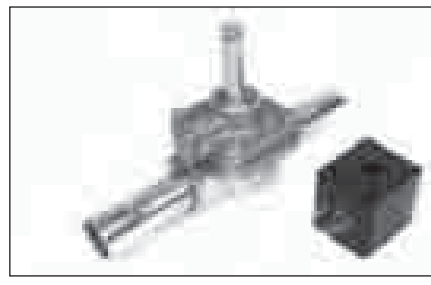

Valve, Solenoid

Order Part #: P-14-00230-01SV
(Replaces Carrier #: 14-00230-01SV)



Washer

Order Part #: P-34-01226-00
(Replaces Carrier #: 34-01226-00)

ALSO AVAILABLE



Alternator, 40 Amp DC
OrderPart# P-96-111-02K
(Replaces Carrier #: 96-111-02K)

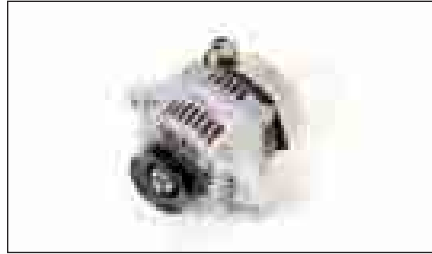

Alternator, 60 Amp DC
OrderPart# P-96-101-21K
(Replaces Carrier #: 96-101-21K)



**Belt, Alternator/Fan/
Water Pump**
OrderPart# P-96-969-03K
(Replaces Carrier #: 96-969-03K)

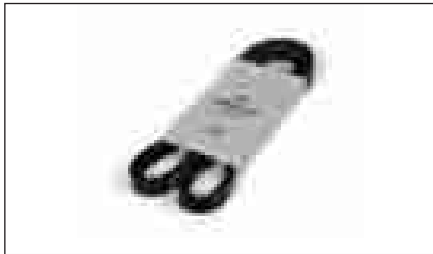

Belt, Generator
OrderPart# P-40-304-01K
(Replaces Carrier #: 40-304-01K)



Capacitor, 25 MFD
OrderPart# P-40-203-20K
(Replaces Carrier #: 40-203-20K)



Drier
OrderPart# P-55-831-01K
(Replaces Carrier #: 55-831-01K)



Compressor, Base R22
OrderPart# P-55-376-01KC
(Replaces Carrier #: 55-376-01K)



Compressor, Base 134a
OrderPart# P-55-810-01KC
(Replaces Carrier #: 55-810-01K)

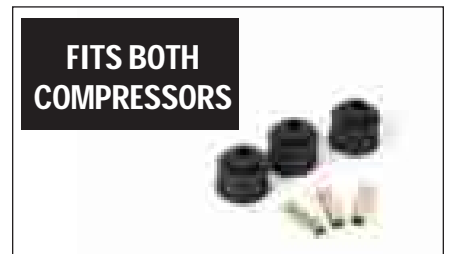

**Compressor, Shockmount
& Hardware Kit**
OrderPart# P-30-781-05KPG
(Replaces Carrier #: 30-781-05K)

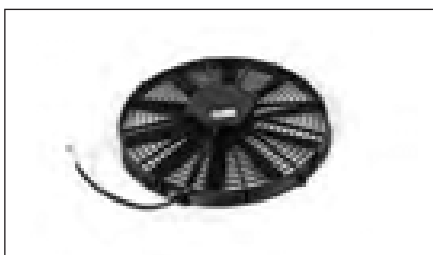

Fan, Axial kit
OrderPart# P-55-352-01K
(Replaces Carrier #: 55-352-01K)



Filter, Air
OrderPart# P-30-60049-20
(Replaces Carrier #: 30-724-11K)



Filter, Fuel
OrderPart# P-30-814-11K
(Replaces Carrier #: 30-814-11K)
Single Part# P-30-814-11KS

COMFORT PRO

COMFORT PRO Parts

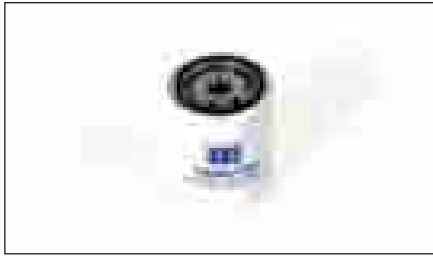

Filter, Fuel

OrderPart# P-96-101-24K
 (Replaces Carrier #: 96-101-24K)
 Single Part# P-96-101-24KS

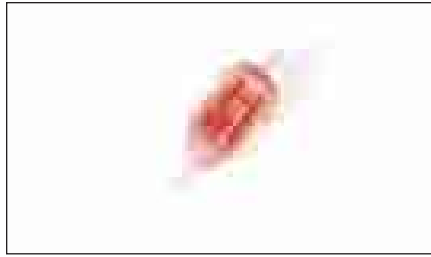

Filter, Fuel In-Line

OrderPart# P-30-186-02K
 (Replaces Carrier #: 30-186-02K)
 Single Part# P-30-186-02KS

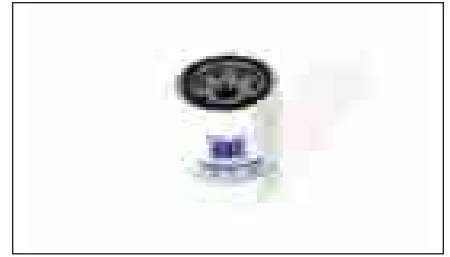

Filter, Oil

OrderPart# P-96-101-33K
 (Replaces Carrier #: 96-101-33K)
 Single Part# P-96-101-33KS



Filter, Oil

OrderPart# P-96-952-02K
 (Replaces Carrier #: 96-952-02K)
 Single Part# P-96-952-02KS

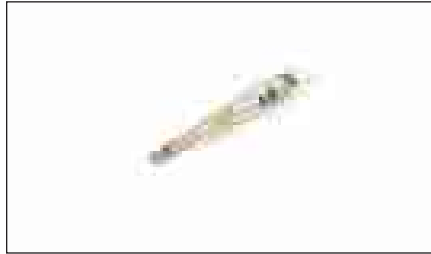

Glow Plug

OrderPart# P-25-15330-00
 (Replaces Carrier #: 96-937-00K)



Pulley, Fan

OrderPart# P-96-969-04K
 (Replaces Carrier #: 96-969-04K)



Injector, c/w gasket and heat seal

OrderPart# P-96-943-00K
 (Replaces Carrier #: 96-943-00K)



Gasket, Injector

OrderPart# P-25-34216-00
 (Replaces Carrier #: 96-943-01K)

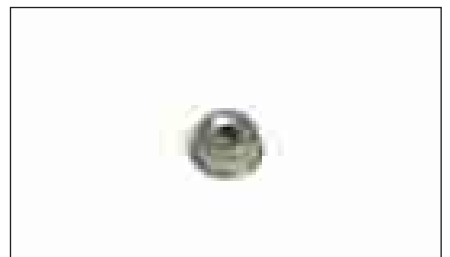

Seal, Heat injector

OrderPart# P-25-39147-00
 (Replaces Carrier #: 96-943-02K)



Pump, Fuel suction

OrderPart# P-30-377-01K
 (Replaces Carrier #: 30-377-01K)

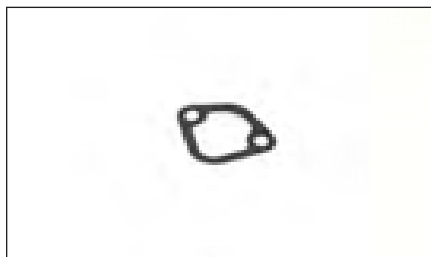

Gasket, Fuel pump

OrderPart# P-30-378-02K
 (Replaces Carrier #: 30-378-02K)

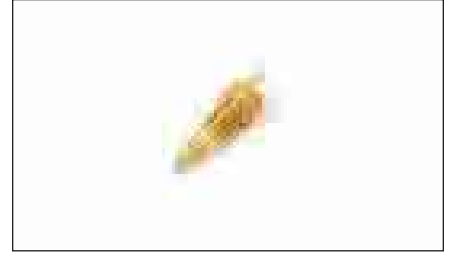

Sensor, Coolant

OrderPart# P-30-266-01K
 (Replaces Carrier #: 30-266-01K)

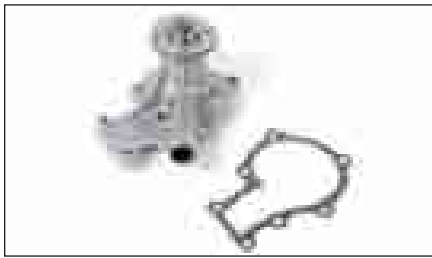

Pump, Water
 OrderPart# P-25-34330-00SVB
 (Replaces Carrier #: 30-123-01K)

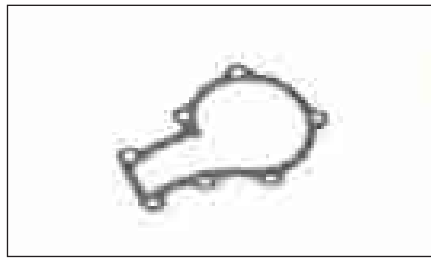

Gasket, Water pump
 OrderPart# P-25-34333-00
 (Replaces Carrier #: 30-124-01K)

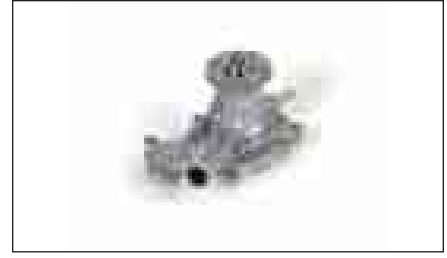

Pump, Water (New style)
 OrderPart# P-96-101-30k
 (Replaces Carrier #: 96-101-30K)

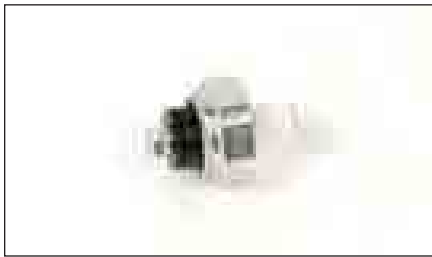

Sensor, Oil pressure
 OrderPart# P-96-949-00K
 (Replaces Carrier #: 96-949-00K)

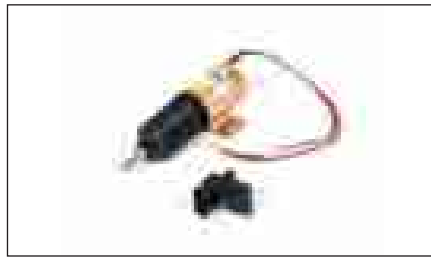

Solenoid, Fuel c/w connector
 OrderPart# 30-122-05K
 (Replaces Carrier #: 30-122-05K)



Solenoid, Fuel shutoff
 OrderPart# P-96-153-01K
 (Replaces Carrier #: 96-153-01K)



Starter, Engine
 OrderPart# P-25-34885-00
 (Replaces Carrier #: 30-125-01K)



Solenoid, Starter
 OrderPart# P-25-34893-00
 (Replaces Carrier #: 30-125-02K)



Starter, Engine c/w solenoid
 OrderPart# P-96-101-22K
 (Replaces Carrier #: 96-101-22K)



Switch, Binary
 OrderPart# P-55-851-01K
 (Replaces Carrier #: 55-851-01K)

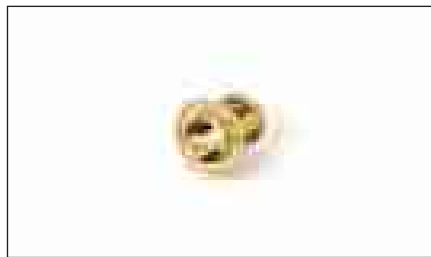

Thermostat, Engine
 OrderPart# P-25-34309-01
 (Replaces Carrier #: 30-228-01K)

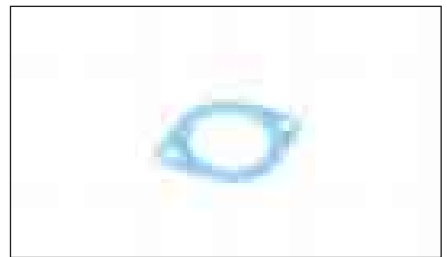

Gasket, Thermostat
 OrderPart# P-25-36676-00
 (Replaces Carrier #: 30-229-01K)

Also Available:
TXV, kit
 OrderPart# P-55-817-01K
 (Replaces Carrier #: 55-817-01K)

COMFORT PRO

Thermo Gard™ Service & Maintenance Solutions

Choose the program that best fits your business needs



Platinum

The best reefer service anywhere.

Our Platinum Guaranteed Maintenance program provides the ultimate in preventive and predictive refrigeration unit maintenance. Platinum offers solutions by customizing maintenance programs to meet your specific needs, immediate and long term.

Choose from Four Levels of Platinum Protection:

Platinum Premier

- Fixed cost for easy budgeting with no surprises
- Comprehensive program tailored to maximize uptime
- Includes coverage for all scheduled maintenance and all unscheduled or breakdown service
- Service performed by factory trained technicians at any of over 200 participating dealer locations in North America
- 24/7 access to expedited service
- Lessens your risk and puts the responsibility on us

Platinum Essential

- Allows you to exchange the major component coverage of Platinum Premier for a lower cost coverage option
- Guaranteed time and materials rates for engine, compressor, and microprocessor repairs
- Service performed by factory trained technicians at any of over 200 participating dealer locations in North America
- Provides more economical coverage alternative for older equipment

Platinum PM

- Includes preventive maintenance service at factory recommended intervals:
 - Comprehensive 60-point inspection
 - Oil change
 - Oil and fuel filter replacement
- Coverage available at a fixed cost for terms of 3 to 7 years
- Service performed by factory trained technicians at any of over 200 participating dealer locations in North America
- Same affordable rates regardless of equipment age

Platinum PM+

Includes everything from Platinum PM **plus**:

- Air filter replacement at recommended intervals
- One interim inspection annually

PG Parts Warranty Periods

COMPONENT	DEALER INSTALLED	CUSTOMER INSTALLED
Basic Components or Parts	90 days	90 days
Starter/Alternator (new)	1 year	1 year
Alternator (reman)	9 months	9 months
Compressors (reman)	2 years	2 years
Engines (reman)	2 years	2 years
Microprocessor keypad (reman)	1 year	1 year

Coverage

- Warranty coverage commences on the date the part is sold by the dealer
- Includes PART ONLY for Aftermarket Parts
- Labor to replace a defective part that fails within the warranty period is at the owner's expense
- Coverage EXCLUDES labor to remove & replace assembly from unit, motor oil, and refrigerant or other miscellaneous or incidental material, parts or labor
- The unexpired portion of the original new unit warranty shall supersede the replacement parts warranty in any case where applicable

The following statement of warranty appears on the reverse side of the customer's copy of the Warranty Registration report for Major Service Parts:

Manufacturer's Warranty

Subject to the conditions hereinafter stated, Thermo King Corporation ("Thermo King") warrants its parts to be free from defects in material and workmanship for a period of 90 days from the date of original sale by a Thermo King Dealer, unless Thermo King has notified the owner in writing of an extended warranty on a specific part. Such warranty extends only to the original owner of the equipment and is limited to Thermo King's option to repair or replacement with new or remanufactured parts at an authorized Thermo King dealer or service agency of any parts which are found by Thermo King to have been defective under normal use and service within the specified warranty period. Such repair or replacement shall be the owner's exclusive remedy and correction of defects in the above manner shall constitute complete fulfillment of all obligations and liabilities of Thermo King with respect to the parts sold hereunder, whether based in contract, in tort (including negligence and/or strict liability), or otherwise. The decision of Thermo King shall be final and conclusive on any question in connection with the application or scope of this warranty.

Warranty Services

Any defective part will be repaired or replaced under the terms of this warranty by an authorized Thermo King dealer or service agency without charge to the owner except for labor and incidental expenses, unless Thermo King has notified the owner in writing that certain labor cost are covered. Any part which is replaced shall become property of Thermo King. Such warranty services will be performed by authorized Thermo King dealer or service agency at its premises during regular working hours and will not include overtime, mileage, telephone calls or telegrams, cost of transportation and/or relocation of equipment or personnel, or other incidental expenses. Where repairs under warranty are made outside the United States, the owner will be charged any customs duties and taxes applicable to the parts and labor in accordance with the regulations of the country where such warranty repairs are performed. This certificate when presented to an authorized Thermo King dealer or service agency entitles the original owner to receive the foregoing warranty services. If the registration plate is blank and the owner cannot establish the date in service, the Thermo King dealer or service agency is not authorized to render the warranty services without charge. If a charge is made, the owner must present the defective part and its paid invoice to the Thermo King dealer from whom the part was purchased for validation with Thermo King. The owner should make every effort to receive warranty services from the Thermo King dealer who sold the part. Thermo King's warranty does not include consumable or maintenance items, such as, but not limited to, engine oil, lubricants, fuses, fuel, filters and filter elements, glow plugs, cleaning materials, light bulbs, refrigerant gases, driers and batteries.

Limitation of Liability

Thermo King's warranty shall not apply to any equipment which (i) has been so installed, maintained, repaired or altered as, in Thermo King's judgment, to affect its integrity, (ii) has been subject to misuse, negligent handling or accident, or (iii) has been operated contrary to Thermo King's printed instructions. Thermo King or any authorized Thermo King dealer or service affiliate shall have the right to require that the owner provide maintenance records to show that the equipment has been properly maintained. THIS WARRANTY IS EXCLUSIVE AND IN LIEU OF ALL OTHER WARRANTIES, EXPRESS OR IMPLIED, INCLUDING ALL WARRANTY OF MERCHANTABILITY AND FITNESS FOR A PARTICULAR PURPOSE AND ALL WARRANTIES ARISING FROM COURSE OF PERFORMANCE OR DEALING OR USAGE OF TRADE, EXCEPT OF THE TITLE AND AGAINST PATENT INFRINGEMENT.

Thermo King shall have no liability in contract or in tort (including negligence or strict liability) or otherwise, for any injury or damage caused to vehicles, content, product cargo or other property or for any special, incidental, indirect or consequential damages whatsoever, including, but not limited to, loss or interruption of business, lost profits and loss of use. The remedies of the owner herein are exclusive and the total cumulative liability of Thermo King shall in no event exceed the purchase price of the part in which such liability is based.

Carrier Trailer Units

	ULTIMA	ULTIMA XTC	ULTRA	ULTRA XT	ULTRA XTC	GEN TM900/1000	ADVANTAGE	EXTRA	EXTRA XT
BELTS									
Water Pump	P-50-00162-04	P-50-00162-22	P-50-00162-04	P-50-00162-22	P-50-00162-22	P-50-00162-04	P-50-00162-04	P-50-00162-04	
Alternator	P-50-00179-22	P-50-00162-22	P-50-00162-08 P-50-00179-09 P-50-00179-20 P-50-00178-13	P-50-00162-22	P-50-00162-22	P-50-00179-20	P-50-00179-00	P-50-00179-20	P-50-00162-18
Condenser Fan	P-50-00178-20		P-50-00178-07			P-50-00178-07		P-50-00178-07	
Compressor	P-50-00178-16		P-50-00178-08			P-50-00178-08		P-50-00178-08	P-50-00178-08
Generator			P-50-00178-10						
Lower Drive		P-50-00178-19		P-50-00178-19	P-50-00178-19				
Upper Drive		P-50-00178-26		P-50-00178-24	P-50-00178-24				P-50-00178-24
Drive to J-Shaft							P-50-00178-00		
J-Shaft to F-Shaft							P-50-01161-02 P-50-00183-01		
FILTERS									
Air	P-30-00430-23 P-30-01077-01	P-30-00426-27	P-30-01077-01	P-30-00426-20 P-30-00471-20	P-30-00426-27	P-30-01077-01	P-66U1-2155	P-30-00430-23	P-30-00426-20 P-30-00471-20
Fuel Primary	P-30-01090-05 P-30-01079-01	P-30-01090-05 P-30-01079-01	P-30-01079-01	P-30-01090-05	P-30-01090-05	P-30-01079-01	P-30-50301-01	P-30-01090-05 P-30-01079-01	P-30-01090-05
Fuel Secondary							P-30-00302-00		
Oil	P-30-00323-00		P-30-00323-00	P-30-00450-00	P-30-00463-00 P-30-00450-00	P-30-00323-00	P-30-00323-00	P-30-00323-00	P-30-00450-00
Oil Bypass	P-30-00304-00-B		P-30-00304-00-B			P-30-00304-00-B		P-30-00304-00-B	P-30-00304-00-B
MISC PARTS									
Engine	P-26-50015-00RM	P-26-50015-00RM	P-26-50015-00RM P-26-50004-00RM	P-26-50015-00RM	P-26-50015-00RM	P-26-50015-00RM P-26-50004-00RM			
Compressor	P-18-00059-127RM	P-18-00059-127RM	P-18-00059-127RM P-18-00059-126RM	P-18-00059-127RM	P-18-00059-127RM	P-18-00059-127RM P-18-00059-126RM		P-18-00059-126RM	P-18-00059-126RM
Alternator	P-30-00409-10 P-30-00409-10RM	P-30-00409-10 P-30-00409-10RM	P-30-50326-00	P-30-00409-10 P-30-00409-10RM	P-30-00409-10 P-30-00409-10RM	P-30-00409-10 P-30-00409-10RM	P-30-00423-00	P-50-00162-08	P-30-00409-10 P-30-00409-10RM
Clutch	P-50-00228-02SV	P-50-00236-05-B	P-50-00215-01SV	P-50-00236-05-B	P-50-00236-05-B	P-50-00215-01SV	NA	P-50-00215-01SV	P-50-00236-05-B
Drier	P-14-00209-00	P-14-00209-00	P-14-00209-00	P-14-00209-00	P-14-00209-00	P-14-00209-00		P-14-00209-00	P-14-00209-00
Solenoid Fuel	P-25-38109-05SV	P-25-38109-05SV	P-25-38109-05SV	P-25-38109-05SV	P-25-38109-05SV	P-25-38109-05SV			P-25-38109-05SV
Solenoid Speed	P-10-01178-04SV	P-10-01178-04SV	P-10-01178-04SV	P-10-01178-04SV	P-10-01178-04SV	P-10-01178-04SV	P-10-60018-00SVB	P-10-01178-04SV	P-10-01178-04SV
Starter	P-25-39291-00-B	P-25-39291-00-B	P-25-39291-00-B	P-25-39291-00-B	P-25-39291-00-B	P-25-39291-00-B		P-25-39291-00-B	P-25-39291-00-B
Switch Oil-Press	P-12-00592-00	P-12-00592-00	P-12-00592-00	P-12-00592-00	P-12-00592-00	P-12-00592-00		P-10-00316-00	P-12-00592-00
Switch W-Temp	P-12-00312-03	P-12-01145-03	P-12-00312-03	P-12-00312-03	P-12-01145-03	P-12-00312-03			P-12-00312-03
Switch W-Temp		P-12-00312-03			P-12-00312-03			P-12-00257-00	
Water Pump	P-25-37581-10-B	P-25-37581-10-B	P-25-37581-10-B	P-25-37581-10-B	P-25-37581-10-B	P-25-37581-10-B		P-25-37581-10-B	P-25-37581-10-B

Carrier Truck Units

	Supra 422	Supra 622/644/722/744	Supra 922/944
BELTS			
Water Pump	P-25-34856-00	P-50-60197-04	P-25-33023-00
Alternator	P-50-00179-03	P-50-60006-02	P-50-60006-02
Comp/Elec Motor	P-50-00179-05	P-50-60007-00	P-50-00178-58
Engine to Comp	P-50-60198-44	P-50-00162-53	P-50-01166-00
FILTERS			
Air	NA	NA	P-30-60049-20 P-25-35250-02
Fuel Primary	P-30-01090-05 P-30-01079-01	P-30-01090-05 P-30-01079-01	P-30-01090-05 P-30-01079-01 P-30-00302-00
Oil	P-941172	P-941172	P-30-00323-00
Oil Bypass	P-30-00304-00-B		
MISC PARTS			
Compressor		P-18-60000-04RM	P-18-00059-130RM
Alternator	P-30-00409-10 P-10-00409-10RM	P-30-60050-04	
Clutch	P-50-60029-00-C	P-50-01165-01-C	P-50-50051-04-C
Drier	P-14-01063-03	P-14-00326-00	P-14-00326-00
Fan Motor Evap 12V	P-54-60006-13-B	P-54-60006-13-B	P-54-60006-13-B
Fan Motor Brush 12V	P-54-60006-30PG	P-54-60006-30SV	P-54-60006-30SV
Solenoid Fuel			P-25-15230-01
Solenoid Speed	P-10-60018-00SVB	P-10-01179-00	P-10-60018-00SVB
Switch Pressure R404A		P-12-00309-04	P-12-00309-04
Switch Pressure R22	P-12-00309-01	P-12-00309-01	
Switch Oil Press	P-12-00592-00	P-12-00592-00	P-12-00592-00
Switch Water Temp	P-12-60000-00	P-12-01145-03	P-12-01145-03
Starter	P-25-34885-00	P-25-35465-00	P-29-70158-00
Water Pump	P-25-34935-00SV	P-25-34330-00SVB	P-29-70183-00SVB

Alpha Sequence Index

DESCRIPTION	CARRIER #	COPICS #	ORDER #	Find It On PAGE	ADVANTAGE	EAGLE	EXTRA	GENESIS	R70	OPTIMA	THUNDERBIRD	ULTIMA	ULTRA	EUROPHOENIX	VECTOR	COMFORT PRO PC5000	SUPRA 422	SUPRA 550	SUPRA 622/644	SUPRA 844	SUPRA 850	SUPRA 922/944	SUPRA 950	INTEGRA 40S	INTEGRA 40S	SOLARA	134TV	134DI	134DI	114DI	114TV	91TV	69TV	44TV	29TV	69NT20	69NT40	69NT40511	69NT40449	GEN SET	MINIBUS	COACH													
Hose, Lower Radiator	58-60039-21	3504165	P-58-60039-21	18, 19															X																																				
Hose, Radiator	58-60039-00	3502727	P-58-60039-00	18																		X																																	
Hose, Radiator (Fill)	58-00904-00	3502679	P-58-00904-00	17, 18	X						X																																												
Hose, Radiator (Inlet, Upper)	58-00903-00	3502678	P-58-00903-00	17, 18, 19	X						X																																												
Hose, Radiator (Inlet, Upper)	58-04080-00	3502699	P-58-04080-00	17, 18				X					X																																										
Hose, Radiator (Inlet, Upper)	58-04155-00	3502707	P-58-04155-00	17, 19							X																																												
Hose, Radiator (Inlet)	58-00922-00	3502682	P-58-00922-00	17, 19				X																																															
Hose, Radiator (Lower)	58-60189-00	3502741	P-58-60189-00	19																		X																																	
Hose, Radiator (Outlet, Lower)	58-00801-00	3502665	P-58-00801-00	17, 18, 19	X						X																																												
Hose, Radiator (Outlet, Lower)	58-01317-00	3502693	P-58-01317-00	18, 19							X																																												
Hose, Radiator (Outlet, Lower)	58-04079-00	3502697	P-58-04079-00	17, 18, 19				X					X																																										
Hose, Radiator (Outlet, Upper)	58-00902-02	3502674	P-58-00902-02	17, 18, 20	X						X																																												
Hose, Radiator (Outlet, Upper)	58-04223-04	3502717	P-58-04223-04	18, 20							X																																												
Hose, Radiator (Outlet)	58-00921-00	3502681	P-58-00921-00	17, 20				X																																															
Hose, Radiator (Upper)	58-60002-00	3502724	P-58-60002-00	19, 20														X																																					
Hose, Radiator (Upper)	58-60039-08	3502728	P-58-60039-08	19, 20														X																																					
Hose, Upper Radiator	58-60039-15	3504164	P-58-60039-15	19, 20														X																																					
Hose, Water Return	25-15411-00	3501913	P-25-15411-00	17, 19, 20						X																																													
Hose, Water Return	25-34308-00	3501979	P-25-34308-00	19, 20														X																																					
Hose, Water Return	25-34329-00	3501984	P-25-34329-00	19, 20														X																																					
Hub, Clutch	17-44041-01	3501705	P-17-44041-01	85																																																			
Idler Assy	25-34424-00	3503956	P-25-34424-00	76														X																																					
Idler Assy	50-01152-00	3502576	P-50-01152-00	76				X	X	X	X	X	X																																										
Indicator, Moisture	14-01092-03	3501534	P-14-01092-03	44, 102						X																																													
Indicator, Moisture	14-01092-05	3501535	P-14-01092-05	45																																																			
Indicator, Sightglass	14-00220-00	3501506	P-14-00220-00	45, 88, 102	X	X	X			X	X	X	X																																										
Injector, Fuel (29TV & 44TV) (w/o gasket or seal)	25-34830-00SV	3502008	P-25-34830-00SV	21														X																																					
Injector, Fuel (69TV/91TV) (w/o gasket or seal)	25-15327-00SV	3501909	P-25-15327-00SV	21						X												X																																	
Injector, Fuel (114DI)	25-38155-00	3502156	P-25-38155-00	21																																																			
Injector, Fuel (114DI) (w/o gasket or seal)	25-37625-00	3502135	P-25-37625-00	21																																																			
Injector, Fuel (134DI & 133DI)	25-38640-00	3502174	P-25-38640-00	21, 95	X	X	X			X	X	X	X																																										
Injector, Fuel (w/gasket & seal) (134TV)	25-39145-01	3502209	P-25-39145-01-B	21	X	X	X																																																
Injector, c/w gasket and heat seal	96-943-00K	3504823	P-96-943-00K	110																																																			
Insulator Kit, (Quench Valve)	76-50056-00	3502949	P-76-50056-00	48																																																			
J-Bolt, Battery	34-06058-06	3502366	P-34-06058-06	103																																																			
J-Bolt, Battery Hold Down	34-00955-05	3502360	P-34-00955-05	81																																																			

WE'VE GOT YOUR BACK



Thermo Gard™ Platinum

Fixed Costs. Easy Budgeting. No Surprises.



Contact your Thermo King dealer

or call (952) 886-6014 to enroll in a Thermo Gard maintenance program for your reefer units and TriPac™ systems.



Providing equipment and services to manage controlled-temperature environments for food and other temperature-sensitive products, our Climate Control Technologies sector encompasses both transport and stationary refrigeration solutions. Our product brands include Thermo King®, a world leader in transport temperature control systems, and Hussmann®, a manufacturer of refrigeration and food merchandising equipment.

www.thermoking.com www.hussmann.com www.ingersollrand.com

Distributed by: